



KRAMER ELECTRONICS LTD.

USER MANUAL

MODEL:

RC-74DL
Master Room Controller

P/N: 2900-000691 Rev 4

Contents

1	Introduction	1
2	Getting Started	2
2.1	Achieving the Best Performance	2
2.2	Safety Instructions	3
2.3	Recycling Kramer Products	3
3	Overview	4
3.1	Defining the RC-74DL Master Room Controller	5
4	Connecting the RC-74DL	8
4.1	Connecting the RS-232 Interface	9
4.2	Connecting the Ethernet Port	10
4.3	Grounding the RC-74DL	10
5	Operating the RC-74DL	12
6	Front Panel Button Caps and Labels	13
6.1	Installing the Front Panel Button Caps, Labels	16
7	Technical Specifications	18

Figures

Figure 1:	RC-74DL Master Room Controller - Front Panel	5
Figure 2:	RC-74DL Master Room Controller - Rear	6
Figure 3:	Connecting the RC-74DL Master Room Controller	9
Figure 4:	RS-232 Connection	9
Figure 5:	Grounding Connection Components	10
Figure 6:	Button Cap Orientation	16
Figure 7:	Button Cap Orientation with Label	16
Figure 8:	Placing the Button Cap	16

1 Introduction

Welcome to Kramer Electronics! Since 1981, Kramer Electronics has been providing a world of unique, creative, and affordable solutions to the vast range of problems that confront video, audio, presentation, and broadcasting professionals on a daily basis. In recent years, we have redesigned and upgraded most of our line, making the best even better!

Our 1,000-plus different models now appear in 11 groups that are clearly defined by function: GROUP 1: Distribution Amplifiers; GROUP 2: Switchers and Routers; GROUP 3: Control Systems; GROUP 4: Format/Standards Converters; GROUP 5: Range Extenders and Repeaters; GROUP 6: Specialty AV Products; GROUP 7: Scan Converters and Scalers; GROUP 8: Cables and Connectors; GROUP 9: Room Connectivity; GROUP 10: Accessories and Rack Adapters and GROUP 11: Sierra Products.

Congratulations on purchasing your Kramer **RC-74DL** *Master Room Controller*, which is ideal for the following typical applications:

- Controlling multimedia rooms, such as classrooms, auditoriums, conference rooms, and so on
- Enabling remote control and management of AV equipment

2 Getting Started

We recommend that you:

- Unpack the equipment carefully and save the original box and packaging materials for possible future shipment
- Review the contents of this user manual



Go to http://www.kramerelectronics.com/support/product_downloads.asp to check for up-to-date user manuals, application programs, and to check if firmware upgrades are available (where appropriate).

2.1 Achieving the Best Performance

To achieve the best performance:

- Use only good quality connection cables (we recommend Kramer high-performance, high-resolution cables) to avoid interference, deterioration in signal quality due to poor matching, and elevated noise levels (often associated with low quality cables)
- Do not secure the cables in tight bundles or roll the slack into tight coils
- Avoid interference from neighboring electrical appliances that may adversely influence signal quality
- Position your Kramer **RC-74DL** away from moisture, excessive sunlight and dust



This equipment is to be used only inside a building. It may only be connected to other equipment that is installed inside a building.

2.2 Safety Instructions



Caution: There are no operator serviceable parts inside the unit

Warning: Use only the Kramer Electronics input power wall adapter that is provided with the unit

Warning: Disconnect the power and unplug the unit from the wall before installing

2.3 Recycling Kramer Products

The Waste Electrical and Electronic Equipment (WEEE) Directive 2002/96/EC aims to reduce the amount of WEEE sent for disposal to landfill or incineration by requiring it to be collected and recycled. To comply with the WEEE Directive, Kramer Electronics has made arrangements with the European Advanced Recycling Network (EARN) and will cover any costs of treatment, recycling and recovery of waste Kramer Electronics branded equipment on arrival at the EARN facility. For details of Kramer's recycling arrangements in your particular country go to our recycling pages at <http://www.kramerelectronics.com/support/recycling/>.

3 Overview

The **RC-74DL** is a highly versatile, 3 gang US, master room controller that acts as an all-in-one extended remote control panel for control of AV equipment—especially projectors and associated equipment—in any room (such as classrooms, boardrooms, or auditoriums). It streamlines operations and simplifies control by integrating audio, video, and computer-video sources into a centralized system.

The **RC-74DL** features:

- 12 configurable, RGB backlit, front panel buttons in three groups (configured using the **K-Config** configuration software)
Available from Kramer Electronics on our Web site at <http://www.kramerelectronics.com/support/?soft=k-config>
- 1 configurable rotary up/down controller with direction indicator LEDs (configured using the **K-Config** configuration software)
- 2 general purpose I/O ports that can be configured by **K-Config** as digital inputs, digital outputs or analog inputs for interfacing with a variety of devices such as sensors, switches, LEDs, or relays
- 3 bidirectional RS-232 ports that can control AV equipment such as projectors, LCD and PDP displays, power amplifiers, switchers and scalers
- 4 relay contact closure ports that can control other room items related to the AV system, such as, raising and lowering drapes, a screen or a projector
- IR control on 2 outputs (terminal blocks)
- IR Learning that learns commands from any IR remote
- Compatibility with Kramer **Site-CTRL** software for network remote control and management over the Ethernet port
- 2 K-NET™ control channels that connect compatible user interfaces and supply power and control data over a single cable
K-NET™ is a proprietary Kramer protocol for interconnecting Kramer units
- Flexible control via Ethernet and K-NET

3.1 Defining the RC-74DL Master Room Controller

This section defines the **RC-74DL**.

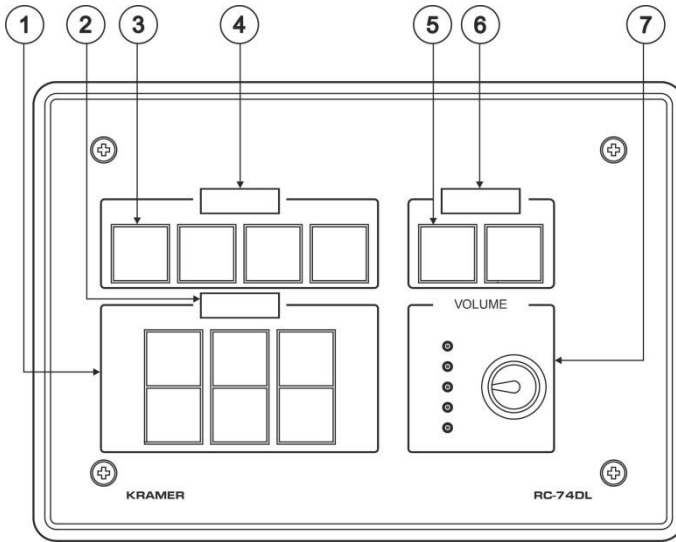

Figure 1: RC-74DL Master Room Controller - Front Panel

#	Feature	Function
1	6 Configurable Button Switches	Function is programmed by the K-Config configuration software
2	LCD Label	Displays up to 8 characters at once (set by the K-Config configuration software)
3	4 Configurable Button Switches	Function is programmed by the K-Config configuration software
4	LCD Label	Displays up to 8 characters at once (set by the K-Config configuration software)
5	2 Configurable Button Switches	Function is programmed by the K-Config configuration software
6	LCD Label	Displays up to 8 characters at once (set by the K-Config configuration software)
7	Rotary switch up/down LED indicator	Indicates the direction of travel of the rotary switch
	VOLUME Rotary Switch	Function is programmed by the K-Config configuration software

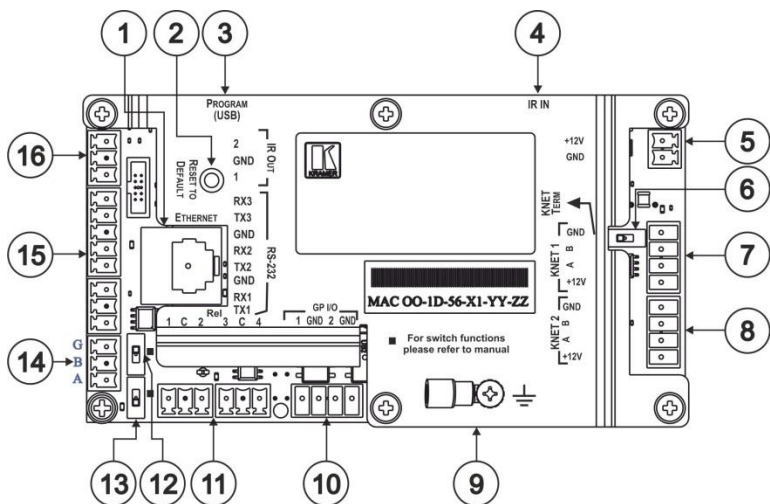

Figure 2: RC-74DL Master Room Controller - Rear

#	Feature	Function
1	ETHERNET RJ-45 Connector	Connects to the PC or other serial controller through computer LAN
2	RESET TO DEFAULT Button	<p>Caution: The current LCD text and all button actions are erased</p> <p>This operation should be carried out by authorized Kramer technical personnel or by an external system integrator, and requires removal of the device from the wall by unscrewing the four wall mount screws</p> <p>Using a small screwdriver, push to erase all custom programming and reset to the factory default definitions:</p> <p>Disconnect the power and then connect it while pressing the Factory Reset button. The unit powers up and load its memory with the factory default definitions</p> <p>IP Address: 192.168.1.39 Mask: 255.255.0.0 Gateway: 0.0.0.0</p>
3	PROGRAM (USB) Connector	Connect to a computer for firmware upgrade or for uploading the configuration file
4	IR IN built-in IR receiver	Use to learn the IR commands from a machine's remote control transmitter
5	Power Supply 2-pin Terminal Block Connector	Connect to power supply (see Section 4.1). Connect GND to GND, +12V to +12V
6	K-NET TERM Switch	<p>Slide to the left (in the direction of the arrow) for K-NET termination, slide to the right up to leave bus unterminated</p> <p>The last physical device on a K-NET bus must be terminated</p>

#	Feature	Function
7	<i>K-NET1</i> Connector	Connect the GND pin to the Ground connection; pin B (-) and pin A (+) are for RS-485, and the +12V pin is for powering the unit The ground connection is sometimes connected to the shield of the RS-485 cable (in most applications, it is not connected)
8	<i>K-NET2</i> Connector	Connect the GND pin to the Ground connection (see Section 4.3 ; pin B (-) and pin A (+) are for RS-485, and the +12V pin is for powering the unit
9	Ring Tongue Terminal Grounding Screw	Connect to grounding wire (optional), (see Section 4.3)
10	<i>GP I/O</i> Terminal Blocks (1 and 2)	Connect to various sensors, switches, LEDs, or relays
11	<i>Rel</i> (Relay) Terminal Blocks	Connect to low-voltage relay-driven devices (from 1 to 4)
12	Switch	For internal factory use only
13	RS-485 Termination Switch	Slide down for RS-485 termination with 120Ω; slide up for no RS-485 Line Termination The first and the last units on the RS-485 line should be terminated (ON). Other units should be unterminated (OFF)
14	<i>RS-485</i> Terminal Block Connector	Connect to the RS-485 detachable terminal block on a switcher or PC
15	<i>RS-232</i> Terminal Blocks	Connect to the RS-232 devices (from 1 to 3)
16	<i>IR</i> Output Terminal Blocks	Connect to IR emitter cables (from 1 to 2)

4 Connecting the RC-74DL



Always switch off the power to each device before connecting it to your **RC-74DL**. After connecting your **RC-74DL**, connect its power and then switch on the power to each device.

To connect the **RC-74DL**, as shown in [Figure 3](#), do the following:

1. Connect the IR outputs as follows:
 - Connect an IR emitter to IR OUTPUT 1 and attach the emitter to the DVD player
 - Connect an IR emitter to IR OUTPUT 2 and attach the emitter to the power amplifier
2. Connect the RS-232 ports (see [Section 4.3](#)) as follows:
 - Connect RS-232 port 1 to the projector
 - Connect RS-232 port 3 to the plasma display
3. Connect the RELAY terminal block connectors as follows:
 - Connect RELAY 1 and 2 to the screen
 - Connect RELAY 3 and 4 to the lighting system
4. Connect the GPI/O 1 port to a motion detector.
5. Connect the Ethernet port to a network (not shown in [Figure 3](#)).
6. Connect the K-NET port to any **RC** device with K-NET (for example, the **RC-63DL**).

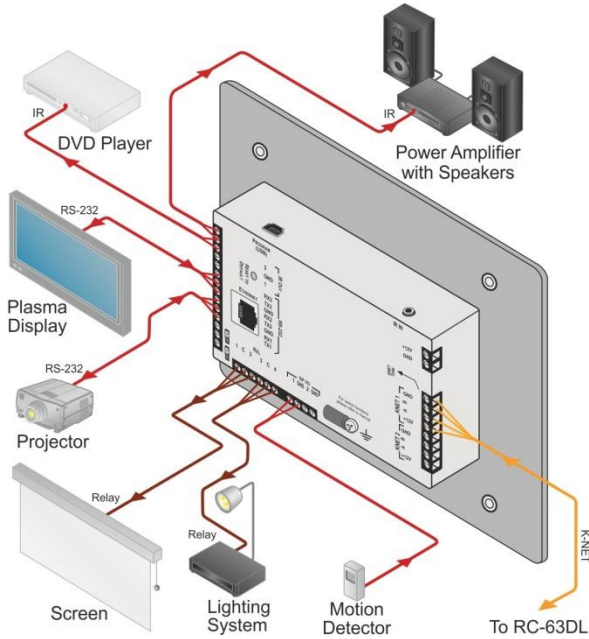

Figure 3: Connecting the RC-74DL Master Room Controller

4.1 Connecting the RS-232 Interface

To connect an AV device to the **RC-74DL** using the RS-232 port, connect the RS-232 9-pin D-sub port on your AV device to the RS-232 terminal block on the rear panel of the **RC-74DL** as shown in [Figure 4](#).

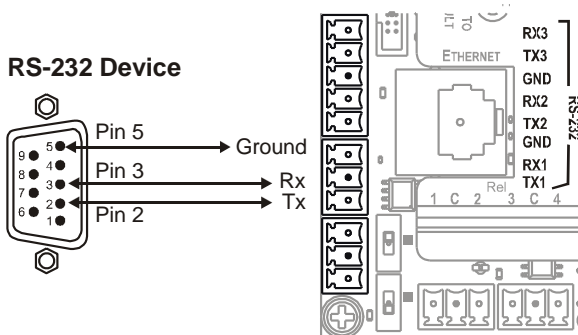

Figure 4: RS-232 Connection

4.2 Connecting the Ethernet Port

The Ethernet connection of the **RC-74DL** lets you perform all control functions of the **RC-74DL** over the Internet using a PC running the Kramer Site-CTRL control program.

To connect the **RC-74DL** to a network:

1. Connect the Ethernet port of the **RC-74DL** to the Ethernet port on a network hub or network router, via a straight cable with RJ-45 connectors.
2. At the other end, connect the Internet to a PC running **Site-CTRL**.
3. After connecting the Ethernet port, you have to install and configure it. For detailed instructions on how to install and configure your Ethernet port, see the *K-Config Software Guide* available from our Web site.

4.3 Grounding the RC-74DL

The grounding screw is used to earth the chassis of the unit to the building ground preventing static electricity from impacting the performance of the unit.

[Figure 5](#) shows the grounding screw components.

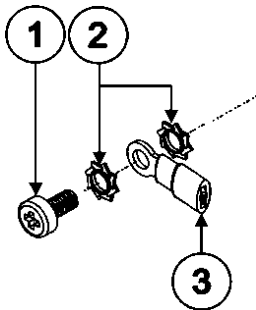

#	Component Description
1	M3X6 screw
2	1/8" Toothed Lock Washer
3	M3 Ring Tongue Terminal

Figure 5: Grounding Connection Components

To ground the **RC-74DL**:

1. Connect the Ring Tongue terminal to the building grounding point wire (it is recommended to use a green-yellow AWG#18 (0.82mm²) wire, crimped with a proper hand-tool).
2. Insert the M3x6 screw through the toothed lock washers and the tongue terminal in the order shown above.
3. Insert the M3x6 screw (with the two toothed lock washers and ring tongue terminal) into the grounding screw hole and tighten the screw.

5 Operating the RC-74DL

You can operate your **RC-74DL** using:

- The front panel buttons. These are configured using the **K-Config** software. For instructions on using the software, see the *K-Config Software Guide* available from our Web site
- A PC running **Site-CTRL** control software:
To operate your device using **Site-CTRL**, see the *Site-CTRL User Guide* available at the Kramer Web site

6 Front Panel Button Caps and Labels

The **RC-74DL** is supplied with a button label sheet and 12 clear, button caps to house the labels. The following illustration shows the sample button label sheets.

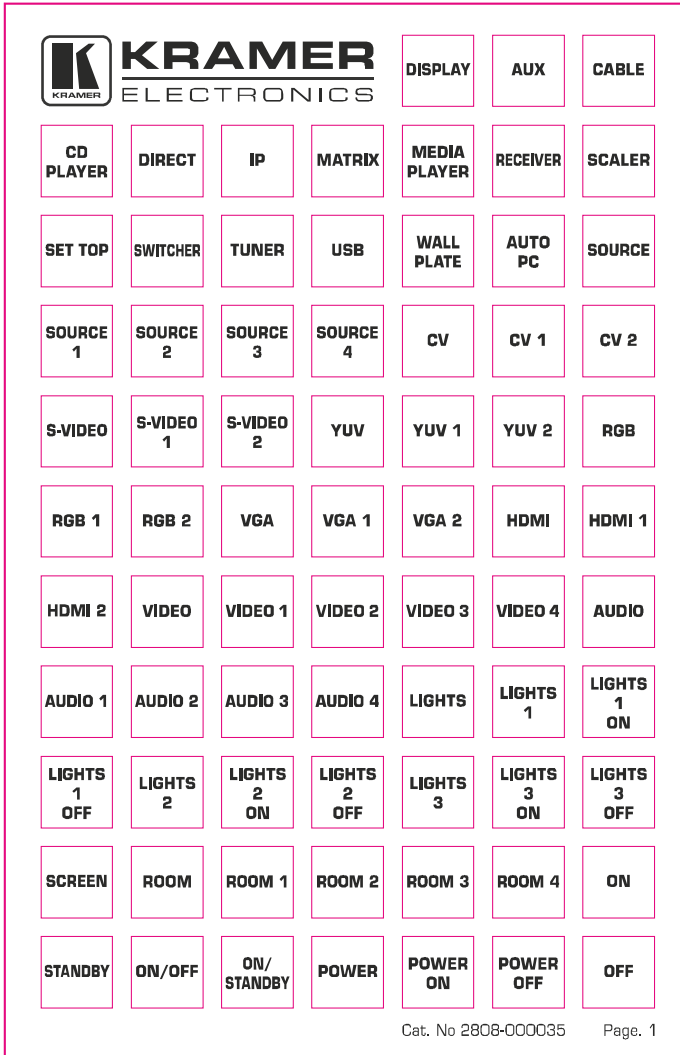

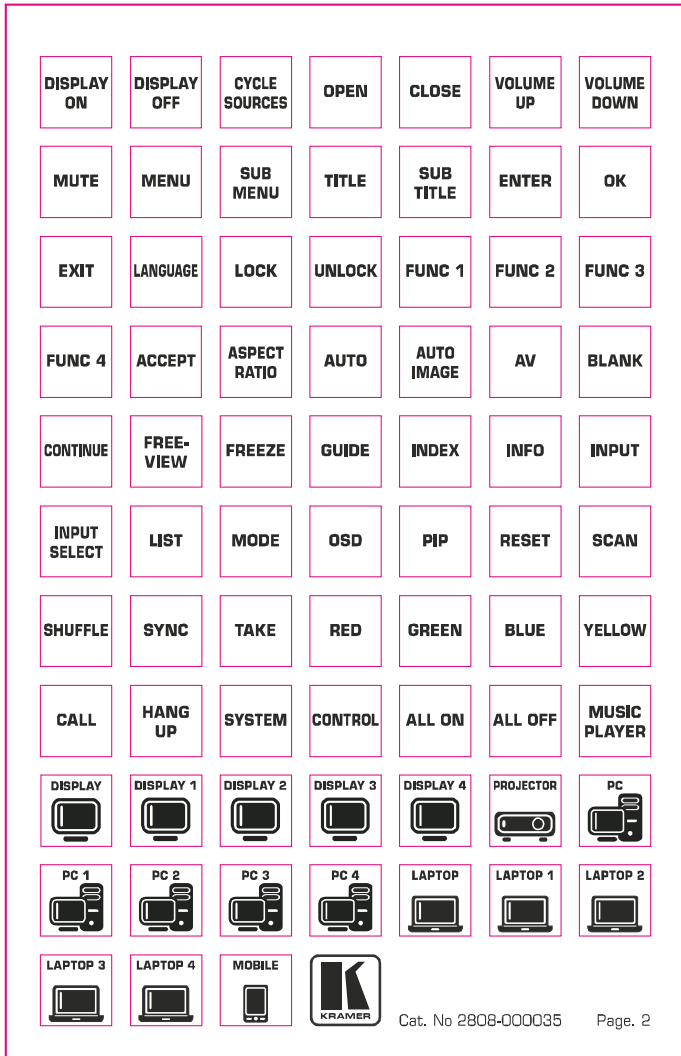

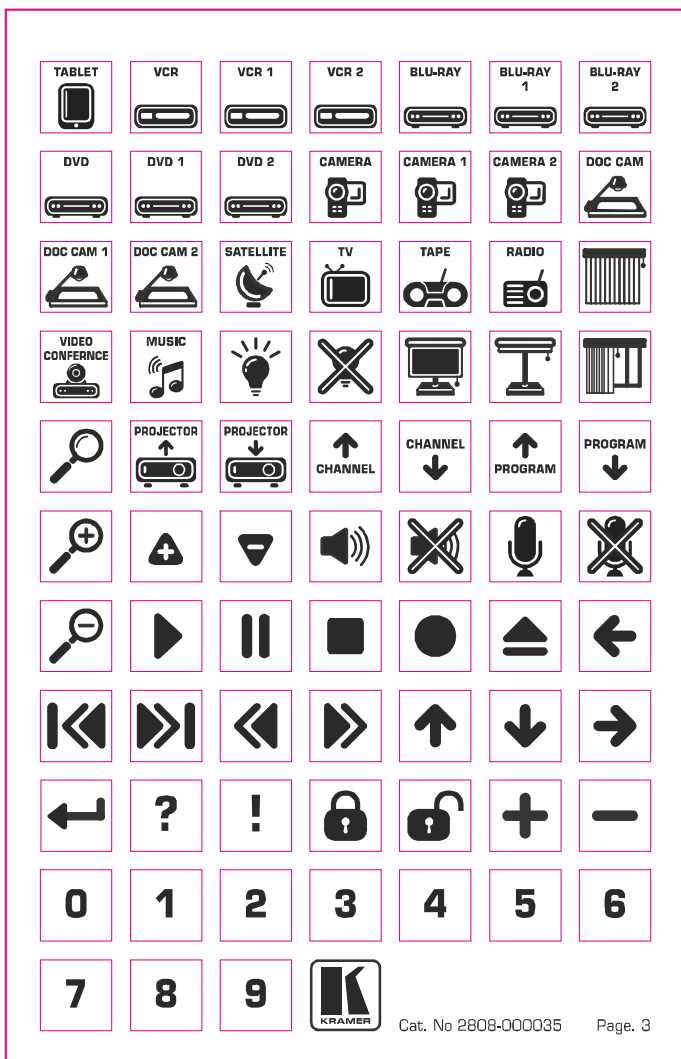

6.1 Installing the Front Panel Button Caps, Labels

To install the button caps and labels:

1. Remove the required labels from the supplied button label sheet.
2. Hold the button cap so that it is oriented as shown in [Figure 6](#) with the “wings” on the left and right sides.



Figure 6: Button Cap Orientation

3. Insert the label inside the cap.



Figure 7: Button Cap Orientation with Label

4. Retaining the orientation, place the button cap on the buttons of the **RC-74DL**.

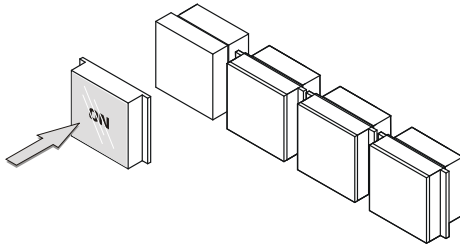

Figure 8: Placing the Button Cap

5. Repeat for all caps.
6. Remove the protective foils from both sides of the Perspex (acrylic glass) windows.
7. Place the faceplate on the **RC-74DL** so that the four screw mounting holes are aligned.

8. Insert the four mounting screws and tighten with a screwdriver.
9. Install the volume control knob.

7 Technical Specifications

INPUTS:	3 RS-232, 1 RS-485, 2 GPI/O and 2 K-NET on terminal block connectors; Ethernet on an RJ-45 connector; 1 infrared sensor, 1 USB for programming
OUTPUTS:	2 IR, 4 relays (36V AC or DC, 2A, 60VAC maximum on non-inductive load) and 2 GPI/O on terminal block connectors
DEFAULT IP SETTINGS:	IP number – 192.168.1.39; Mask – 255.255.0.0; Gateway – 0.0.0.0
POWER CONSUMPTION:	12V DC, 570mA
OPERATING TEMPERATURE:	0° to +40°C (32° to 104°F)
STORAGE TEMPERATURE:	-40° to +70°C (-40° to 158°F)
HUMIDITY:	10% to 90%, RHL non-condensing
DIMENSIONS:	16.2cm x 2.6cm x 11.4 (6.4" x 1.0" x 4.5") W, D, H
WEIGHT:	0.6kg (1.4lbs) approx.
INCLUDED ACCESSORIES:	Power supply, Kramer K-Config Windows®-based configuration software
OPTIONAL ACCESSORIES:	IR emitter cables, KPOD-301, OWB-3G
Specifications are subject to change without notice at http://www.kramerelectronics.com	

LIMITED WARRANTY

The warranty obligations of Kramer Electronics for this product are limited to the terms set forth below.

What is Covered

This limited warranty covers defects in materials and workmanship in this product.

What is Not Covered

This limited warranty does not cover any damage, deterioration or malfunction resulting from any alteration, modification, improper or unreasonable use or maintenance, misuse, abuse, accident, neglect, exposure to excess moisture, fire, improper packing and shipping (such claims must be presented to the carrier), lightning, power surges, or other acts of nature. This limited warranty does not cover any damage, deterioration or malfunction resulting from the installation or removal of this product from any installation, any unauthorized tampering with this product, any repairs attempted by anyone unauthorized by Kramer Electronics to make such repairs, or any other cause which does not relate directly to a defect in materials and/or workmanship of this product. This limited warranty does not cover cartons, equipment enclosures, cables or accessories used in conjunction with this product.

Without limiting any other exclusion herein, Kramer Electronics does not warrant that the product covered hereby, including, without limitation, the technology and/or integrated circuit(s) included in the product, will not become obsolete or that such items are or will remain compatible with any other product or technology with which the product may be used.

How Long Does this Coverage Last

Seven years as of this printing; please check our Web site for the most current and accurate warranty information.

Who is Covered

Only the original purchaser of this product is covered under this limited warranty. This limited warranty is not transferable to subsequent purchasers or owners of this product.

What Kramer Electronics will do

Kramer Electronics will, at its sole option, provide one of the following three remedies to whatever extent it shall deem necessary to satisfy a proper claim under this limited warranty:

1. Elect to repair or facilitate the repair of any defective parts within a reasonable period of time, free of any charge for the necessary parts and labor to complete the repair and restore this product to its proper operating condition. Kramer Electronics will also pay the shipping costs necessary to return this product once the repair is complete.
2. Replace this product with a direct replacement or with a similar product deemed by Kramer Electronics to perform substantially the same function as the original product.
3. Issue a refund of the original purchase price less depreciation to be determined based on the age of the product at the time remedy is sought under this limited warranty.

What Kramer Electronics will not do Under This Limited Warranty

If this product is returned to Kramer Electronics or the authorized dealer from which it was purchased or any other party authorized to repair Kramer Electronics products, this product must be insured during shipment, with the insurance and shipping charges prepaid by you. If this product is returned uninsured, you assume all risks of loss or damage during shipment. Kramer Electronics will not be responsible for any costs related to the removal or re-installation of this product from or into any installation. Kramer Electronics will not be responsible for any costs related to any setting up this product, any adjustment of user controls or any programming required for a specific installation of this product.

How to Obtain a Remedy under this Limited Warranty

To obtain a remedy under this limited warranty, you must contact either the authorized Kramer Electronics reseller from whom you purchased this product or the Kramer Electronics office nearest you. For a list of authorized Kramer Electronics resellers and/or Kramer Electronics authorized service providers, please visit our web site at www.kramerelectronics.com or contact the Kramer Electronics office nearest you.

In order to pursue any remedy under this limited warranty, you must possess an original, dated receipt as proof of purchase from an authorized Kramer Electronics reseller. If this product is returned under this limited warranty, a return authorization number, obtained from Kramer Electronics, will be required. You may also be directed to an authorized reseller or a person authorized by Kramer Electronics to repair the product.

If it is decided that this product should be returned directly to Kramer Electronics, this product should be properly packed, preferably in the original carton, for shipping. Cartons not bearing a return authorization number will be refused.

Limitation on Liability

THE MAXIMUM LIABILITY OF KRAMER ELECTRONICS UNDER THIS LIMITED WARRANTY SHALL NOT EXCEED THE ACTUAL PURCHASE PRICE PAID FOR THE PRODUCT. TO THE MAXIMUM EXTENT PERMITTED BY LAW, KRAMER ELECTRONICS IS NOT RESPONSIBLE FOR DIRECT, SPECIAL, INCIDENTAL OR CONSEQUENTIAL DAMAGES RESULTING FROM ANY BREACH OF WARRANTY OR CONDITION, OR UNDER ANY OTHER LEGAL THEORY. Some countries, districts or states do not allow the exclusion or limitation of relief, special, incidental, consequential or indirect damages, or the limitation of liability to specified amounts, so the above limitations or exclusions may not apply to you.

Exclusive Remedy

TO THE MAXIMUM EXTENT PERMITTED BY LAW, THIS LIMITED WARRANTY AND THE REMEDIES SET FORTH ABOVE ARE EXCLUSIVE AND IN LIEU OF ALL OTHER WARRANTIES, REMEDIES AND CONDITIONS, WHETHER ORAL OR WRITTEN, EXPRESS OR IMPLIED. TO THE MAXIMUM EXTENT PERMITTED BY LAW, KRAMER ELECTRONICS SPECIFICALLY DISCLAIMS ANY AND ALL IMPLIED WARRANTIES, INCLUDING, WITHOUT LIMITATION, WARRANTIES OF MERCHANTABILITY AND FITNESS FOR A PARTICULAR PURPOSE. IF KRAMER ELECTRONICS CANNOT LAWFULLY DISCLAIM OR EXCLUDE IMPLIED WARRANTIES UNDER APPLICABLE LAW, THEN ALL IMPLIED WARRANTIES COVERING THIS PRODUCT, INCLUDING WARRANTIES OF MERCHANTABILITY AND FITNESS FOR A PARTICULAR PURPOSE, SHALL APPLY TO THIS PRODUCT AS PROVIDED UNDER APPLICABLE LAW.

IF ANY PRODUCT TO WHICH THIS LIMITED WARRANTY APPLIES IS A "CONSUMER PRODUCT" UNDER THE MAGNUSON-MOSS WARRANTY ACT (15 U.S.C.A. §2301, ET SEQ.) OR OTHER APPLICABLE LAW, THE FOREGOING DISCLAIMER OF IMPLIED WARRANTIES SHALL NOT APPLY TO YOU, AND ALL IMPLIED WARRANTIES ON THIS PRODUCT, INCLUDING WARRANTIES OF MERCHANTABILITY AND FITNESS FOR THE PARTICULAR PURPOSE, SHALL APPLY AS PROVIDED UNDER APPLICABLE LAW.

Other Conditions

This limited warranty gives you specific legal rights, and you may have other rights which vary from country to country or state to state.

This limited warranty is void if (i) the label bearing the serial number of this product has been removed or defaced, (ii) the product is not distributed by Kramer Electronics or (iii) this product is not purchased from an authorized Kramer Electronics reseller. If you are unsure whether a reseller is an authorized Kramer Electronics reseller, please visit our Web site at www.kramerelectronics.com or contact a Kramer Electronics office from the list at the end of this document.

Your rights under this limited warranty are not diminished if you do not complete and return the product registration form or complete and submit the online product registration form. Kramer Electronics thanks you for purchasing a Kramer Electronics product. We hope it will give you years of satisfaction.



For the latest information on our products and a list of Kramer distributors, visit our Web site where updates to this user manual may be found.

We welcome your questions, comments, and feedback.

Web site: www.kramerelectronics.com

E-mail: info@kramerel.com

CE



SAFETY WARNING

Disconnect the unit from the power supply before opening and servicing



P/N: 2900-000691



Rev: 4