

# **User's Manual**

LED Module

[Models for indoor use]

**LED-FC009i**

**LED-FC012i**

**LED-FC015i**

MODELS: LED-FC009i, LED-FC012i, LED-FC015i

# Table of Contents

---

<b>Important Information .....</b>	<b>English-1</b>
<b>Contents.....</b>	<b>English-5</b>
<b>Related Items for Installation .....</b>	<b>English-6</b>
<b>Parts Name and Functions.....</b>	<b>English-7</b>
<b>Specifications .....</b>	<b>English-9</b>
<b>Diagram .....</b>	<b>English-10</b>

- NOTE:** (1) The contents of this manual may not be reprinted in part or whole without permission.  
(2) The contents of this manual are subject to change without notice.  
(3) Great care has been taken in the preparation of this manual; however, should you notice any questionable points, errors or omissions, please contact us.  
(4) The image shown in this manual is indicative only. If there is inconsistency between the image and the actual product, the actual product shall govern.  
(5) Notwithstanding articles (3) and (4), we will not be responsible for any claims on loss of profit or other matters deemed to result from using this device.

The company names and product names mentioned in this manual are trademarks or registered trademarks of respective companies.



# Important Information

## Safety Precautions and Maintenance



FOR OPTIMUM PERFORMANCE, PLEASE NOTE  
THE FOLLOWING WHEN SETTING UP AND  
USING THE LED DISPLAY SYSTEM:

### About the Symbols

To ensure safe and proper use of the product, this manual uses a number of symbols to prevent injury to you and others as well as damage to property. The symbols and their meanings are described below. Be sure to understand them thoroughly before reading this manual.

















 <b>WARNING</b>	<b>Failing to heed this symbol and handling the product incorrectly could result in accidents leading to major injury or death.</b>
 <b>CAUTION</b>	<b>Failing to heed this symbol and handling the product incorrectly could result in personal injury or damage to surrounding property.</b>

### Examples of symbols









	<b>⚠ Indicates a warning or caution.</b> <b>This symbol indicates you should be careful of electric shocks.</b>
	<b>⊘ Indicates a prohibited action.</b> <b>This symbol indicates something that must be prohibited.</b>
	<b>● Indicates a mandatory action.</b> <b>This symbol indicates that the power cord should be unplugged from the power outlet.</b>

- Be sure to read the following before using the product to use it correctly and safely.

## **WARNING**

-  Do not apply vibrations or shocks to the product.
-  Do not install the product to unstable locations or locations subject to vibrations.
-  Always ask a technician to perform the installation.
-  Do not connect the cables with wet hands. Otherwise, it may cause an injury or an electrical shock.
-  Do not repair or modify the product yourself. Otherwise, it may cause an injury, a fire or an electrical shock.
-  In case of thunder, do not touch the power cord. Otherwise, it may cause an electrical shock.
-  Connect the product to the correct voltage. If the product is connected to a voltage other than the specified voltage, it may lead to a fire or an electrical shock.
-  In case of a malfunction (nothing is displayed on the screen, etc.) or if smoke, abnormal heat, or a strange sound or odor is generated, turn the power off and immediately ask a technician or your retailer for repair.
-  Install the product so that the vents are not obstructed.
-  Make sure there are enough people available to ensure safety (at least two people) when installing or moving the product. Otherwise, it may lead to an injury.
-  Be sure to ground the product. If the product is not grounded, there is a risk of electrical shock in case a malfunction occurs.
-  In case foreign matter has entered into the product, immediately disconnect the power supply and stop using the product.
-  After the installation, if a problem such as loose screws occurs, immediately ask a technician or your retailer for repair.
-  Do not put objects into the product. Otherwise, it may cause a fire or an electrical shock.
-  In case the product is in contact with water or another liquid, immediately disconnect the power supply and stop using the product. If you continue using the product in that state, it may lead to a malfunction, a fire, or an electrical shock.
-  When using the power connector (WAGO), do not use it outdoors or in a humid environment. Otherwise, it may cause a fire or an electrical shock.

## CAUTION

-  When connecting the power cord to the product's AC IN terminal, make sure the connector is fully and firmly inserted.
-  Do not damage the power cord. Do not put heavy objects on it, place it near heaters, pull it with excessive strength, or apply a strong force on it while it is bent. A damaged power cord may cause a fire or an electrical shock.
-  Do not install the product in narrow places where heat tends to build up.
-  Do not use the product in an environment with low heat dissipation. Otherwise, it may cause a malfunction.
-  The RJ-45 port of the product is for use with the product only. Do not connect it to a network. Connecting this port to a network that may receive over-voltage current may cause damage to the product or an electrical shock.
-  Do not use the product in a vehicle or another means of transportation.
-  Do not place the product under direct sunlight or near heaters.
-  This product is designed to be used indoors. Do not use it outdoors. Otherwise, it may cause a malfunction.

Do not use or store the product in the following places.

- 
  - Near heaters
  - Places with lots of humidity or dust, or places subject to oily smoke
  - Places where water or oil may splash
  - Places with lots of corrosive gases, such as near hot springs
  - Places where the product may freeze
  - Do not place the product on its side, face down, or upside down.
  - Places with lots of vibrations

 If you will not be using the product for a long time, disconnect it from the power distributor for safety purposes.

 Disconnect the power supply when performing the maintenance.

 Install the product in accordance with the local laws and regulations.

 Use ESD gloves when handling Pixel cards to prevent static electricity from the human body and contamination due to finger oils, perspiration salts, flaking skin, and/or other forms of human excretory secretions. The LED modules and their electrical components are sensitive to biological agents and exposure to such risks degradation of materials and performance. Eliminate any static electricity from your body before touching the Pixel cards by touching an aluminum sash, a door knob, or some other metal object.

This product can only be serviced in the country where it was purchased.

# Recommended Use & Maintenance

## About the LED lamps



The surface of the pixel card is vulnerable to shocks, so do not press or hit the surface.



LED lamps are sensitive to static electricity and surge voltage, which may damage their components and decrease their reliability.

Take measures against static electricity during the installation. Do not touch the LED display areas.



When you install the product or when you use it for the first time after leaving it unused for a long time, follow the instructions below.

The LED lamps may absorb and hold moisture during the LED module installation or if not used for a long time. Therefore, in such cases, the brightness must be increased gradually during a break-in period before setting the normal brightness.

If the LED lamps are lit with 100% brightness while moisture is retained, the temperature will rise very quickly and the water inside the lamps will evaporate and expand. This will cause the encapsulating resin to expand, which may lead to separation of the boundary surface inside the LED lamps. This separation can cause the LED lamps not to light up properly.

### Lamp break-in

Configure the brightness settings as shown below with a video displayed on the LED module.

After a break-in period of approximately 3 hours, the LED module can be used under normal conditions.

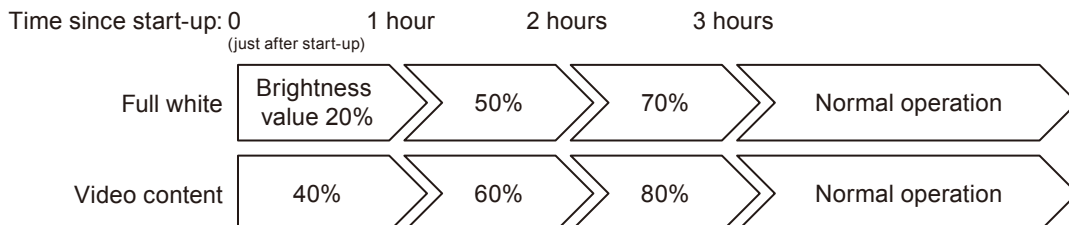

## About the Pixel card



The surface of the pixel card is easily scratched, so handle it with care so as not to push or rub it with a hard object. Be careful not to stain the surface of the pixel card with your fingers. If the surface of the pixel card becomes dirty, wipe it gently with a dry cloth. Also, use a clean cloth and avoid using the same cloth repeatedly.

# Contents

---

The supplied parts are as follows.

In case one of these parts is missing or damaged, contact the retailer.

**⚠ CAUTION**

Depending on the system you ordered, there is a cabinet without the upper connector.

[Cabinet]

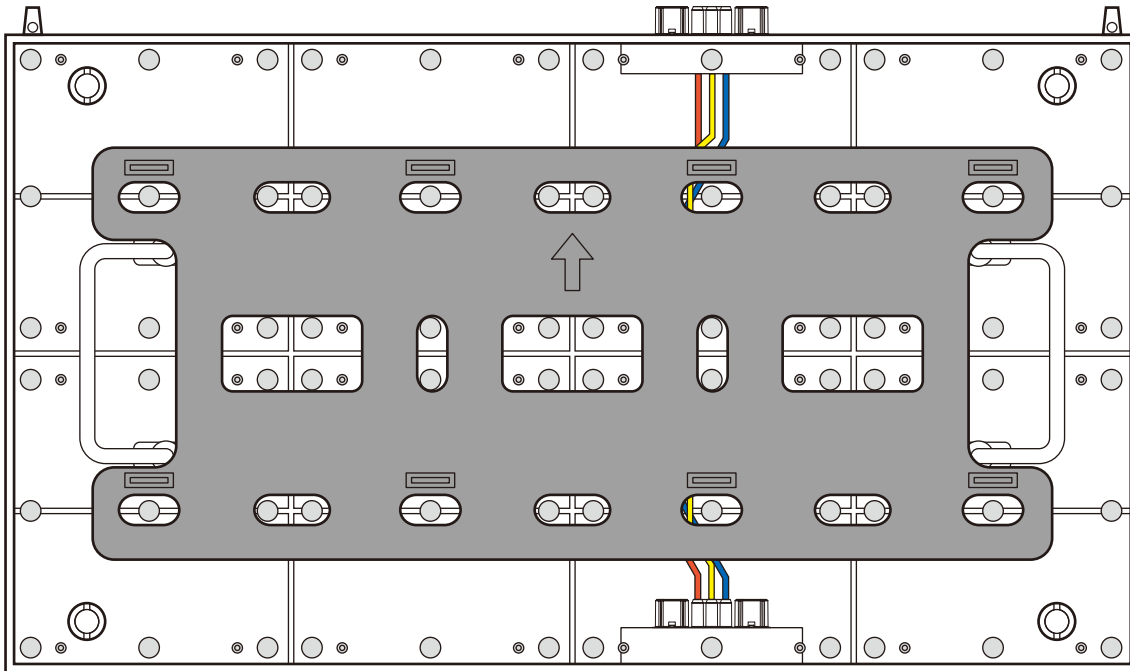

[Pixel card]

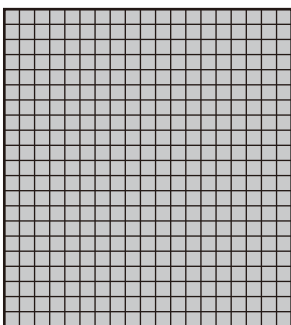

8 cards per cabinet

# Related Items for Installation

---

The items required when installing the system are shown below.  
Contact your retailer for more details.

[Power cord]

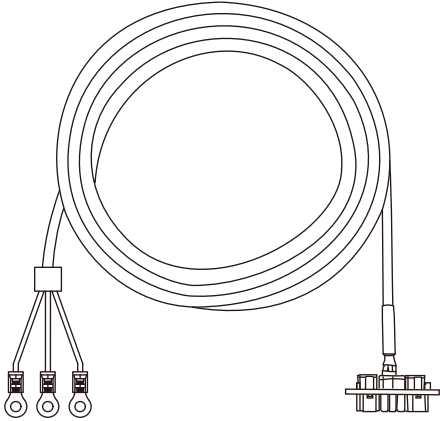

To connect the LED module to the power distributor

[LAN cable]



To connect two LED modules together  
(120 mm for vertical connection, 1000 mm for horizontal connection)

[Cabinet alignment bracket]

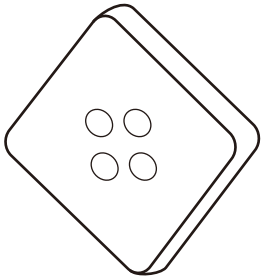

[Connection screw for LED modules]



[USB drive]

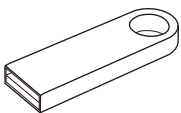

Contains the data, the user's manual (this document), and the control software for the product you have purchased.



# Parts Name and Functions

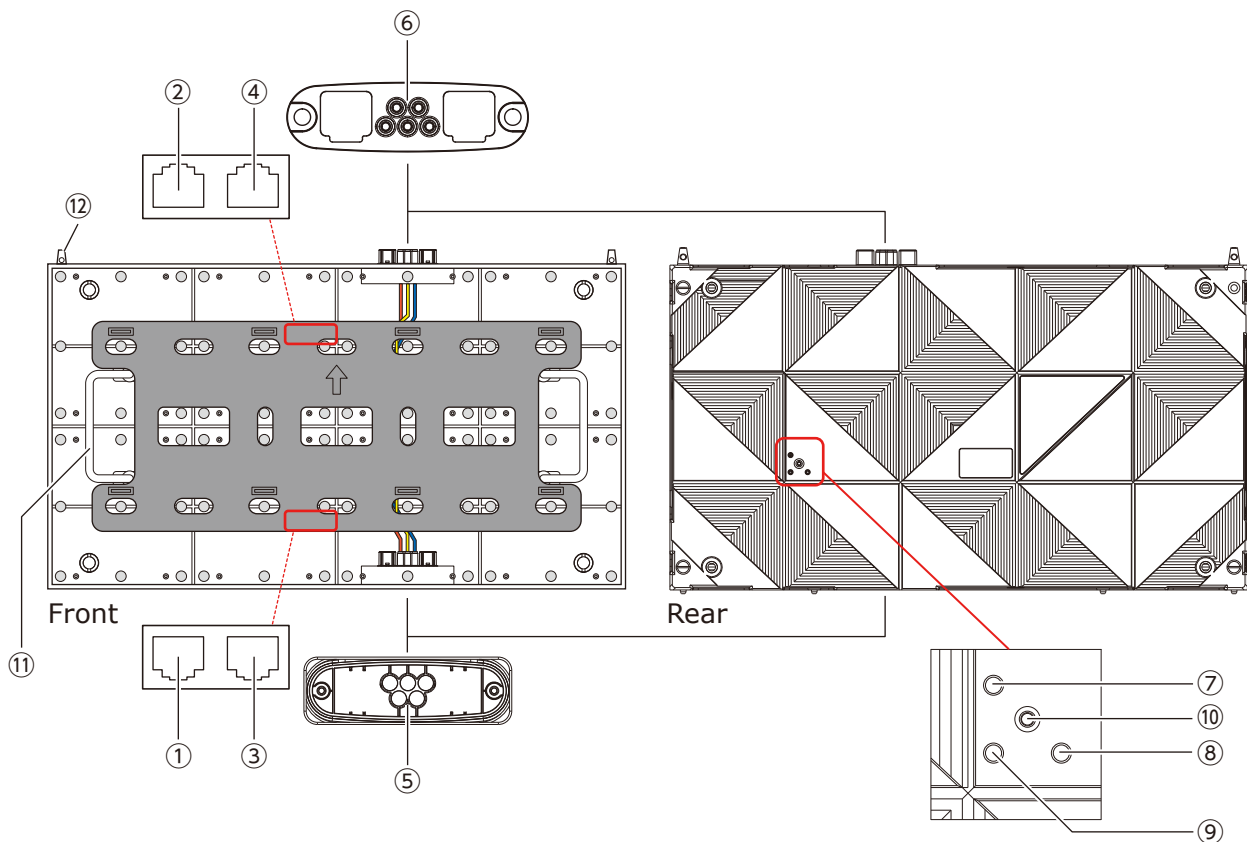

Name	Description
Interface connectors	Input and output connectors for the signal and AC power.
①② Signal input/output	To input the signal from the LED controller or the previous LED module. When a signal is input into ①, the signal is output from ②. When a signal is input into ②, the signal is output from ①.
③④ Signal input/output	Not functioning with this product.
⑤⑥ Power input (output)	When AC power is input into ⑤, AC power is output from ⑥. When AC power is input into ⑥, AC power is output from ⑤. Do not input AC power into both ⑤ and ⑥.
⑦ Status lamp (red)	Lights up when power is on.
⑧ Status lamp (blue)	Not functioning with this device.
⑨ Status lamp (green)	Flashes at intervals of approximately 4 seconds when no signal is input. Flashes at intervals of about 1 second when a signal is being input.
⑩ Test button	Used to display the test patterns. The displayed pattern changes each time the test button is pressed. The signal from the LED controller must be interrupted to display a test pattern.
⑪ Handle	Use the handles when carrying and installing the cabinet.
⑫ Guide pin	Used to align the cabinets when installing them on top of each other.

There are two types of cabinets.

(1) Type A

The connectors are equipped on the top and bottom sides. There are guide pins on the top.

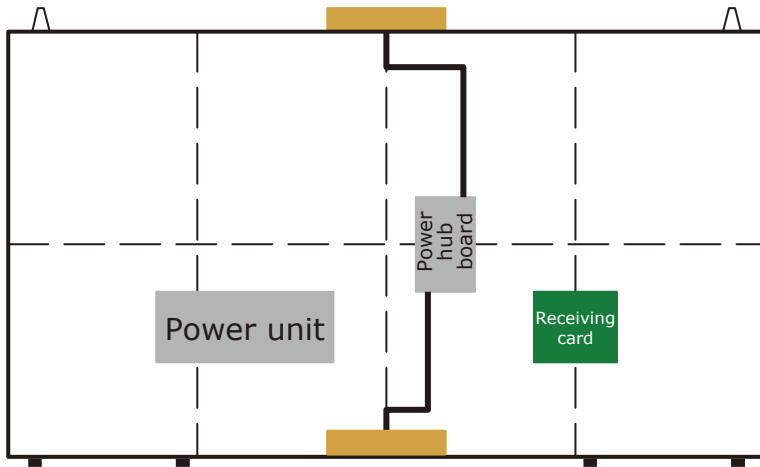

(2) Type B

There are no connectors on the top side. There are no guide pins.

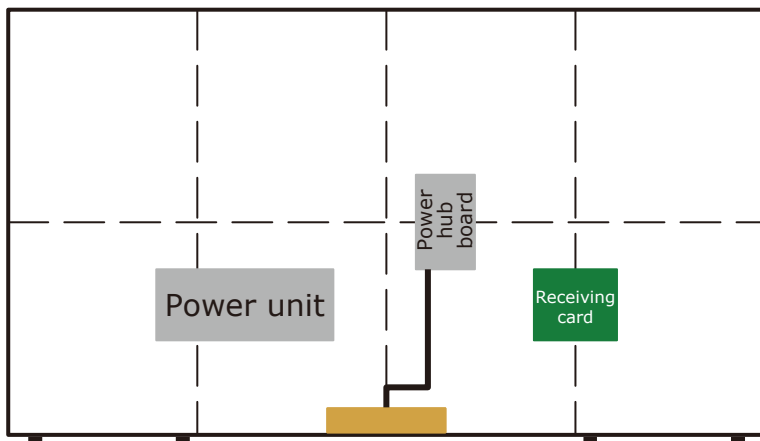

**[When assembling a 6 x 6 frame set using FC009i]**

It is necessary to connect a LAN cable in the middle of the installation work. That is the reason why a model (Type A') with a hole for LAN cable connection on the rear has been made available.

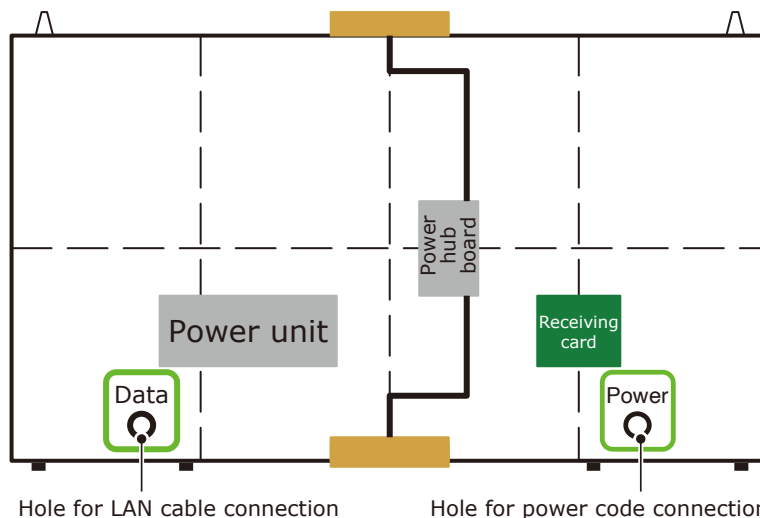

# Specifications

		LED-FC009i	LED-FC012i	LED-FC015i
LED configuration		Flip chip COB (chip size : 4mil*8mil)		
Pixel pitch		0.95 mm	1.26 mm	1.58 mm
Number of displayed pixels (resolution/module)		640 × 340	480 × 270	384 × 216
Brightness		800 cd/m <sup>2</sup>		
Contrast ratio		20000:1		
Brightness adjustment range		0 to 100% (256 increments)		
Gamma correction		1.0 to 4.0 (default setting: 2.8)		
Color temperature		3000 K to 9500 K (default setting: 6500 K)		
Viewing angle		Up 75°, Down 75°, Left 80°, Right 80°	Up 80°, Down 80°, Left 80°, Right 80°	
Signal interface	Signal input	1 × RJ-45		
	Signal output	1 × RJ-45		
Power supply		100 V AC to 240 V AC, 50 Hz/60 Hz		
Power consumption (all white, 100% brightness)		60 W	70 W	65 W
IP rating		Front IP40 / Rear IP20		
Maintenance		Front		
Dimensions		608 × 342 × 48.5 mm		
Weight		7.0 kg		
Operating environment	Temperature	-20 to 40°C		
	Humidity	10% to 80% (without condensation)		
	Altitude	No more than 5000 m		
Storage environment	Temperature	-20 to 45°C		
	Humidity	10% to 85% (without condensation)		

Specifications are subject to change without notice.

# Diagram

LED-FC009i / LED-FC012i / LED-FC015i

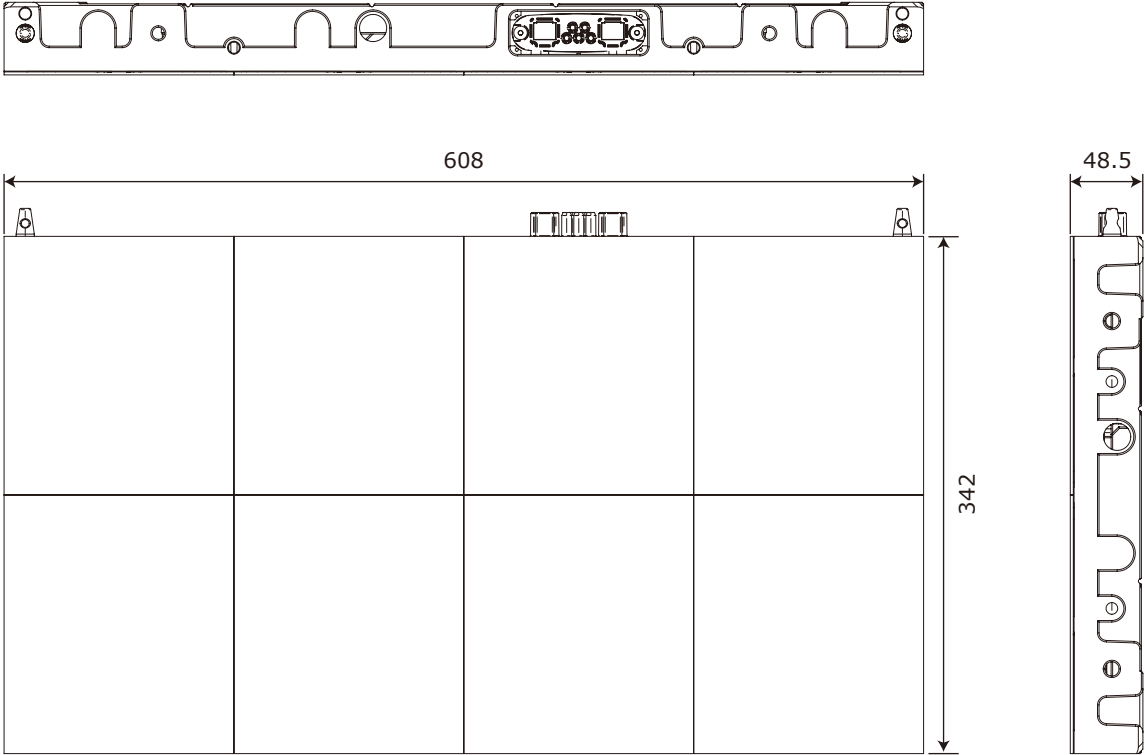

## Rear

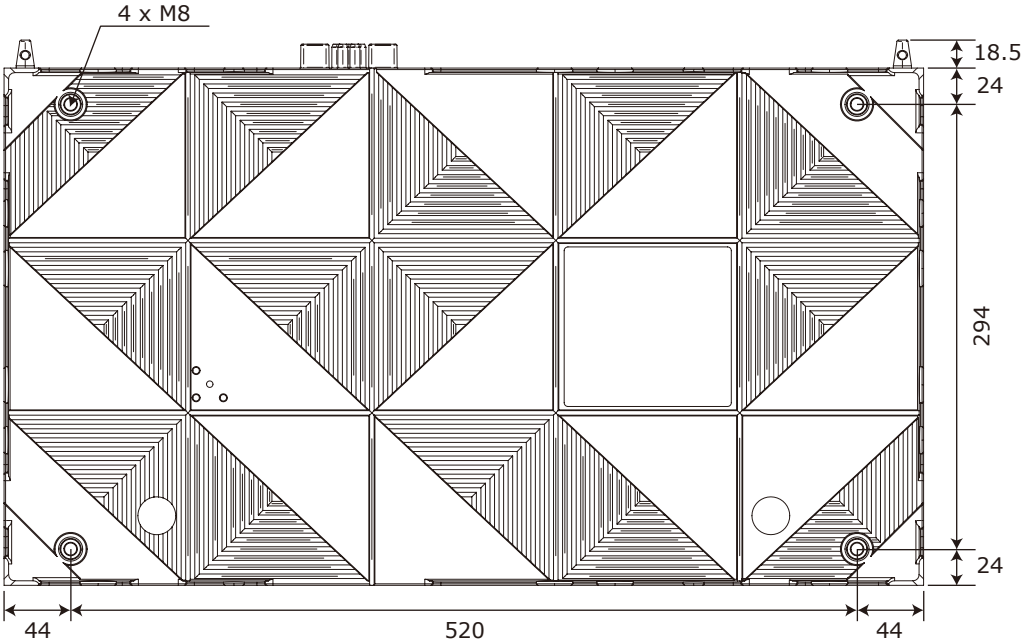

(Unit: mm)

## WEEE Mark (European Directive 2012/19/EU and amendments)



### Disposing of your used product: In the European Union

EU-wide legislation as implemented in each Member State requires that used electrical and electronic products carrying the mark (left) must be disposed of separately from normal household waste. This includes LED module and electrical accessories, such as signal cables or power cords. When you dispose of such products, please follow the guidance of your local authority or ask the shop where you purchased the product, or if applicable, follow applicable legislation or agreement you may have. The mark on electrical and

electronic products may only apply to the current European Union Member States.

### Outside the European Union

If you wish to dispose of used electrical and electronic products outside the European Union, please contact your local authority and ask for the correct method of disposal.



**For EU:** The crossed-out wheeled bin implies that used batteries should not be put to the general household waste! There is a separate collection system for used batteries, to allow proper treatment and recycling in accordance with legislation.

**According to EU directive 2006/66/EC and amendments, the battery can't be disposed improperly. The battery shall be separated to collect by local service.**

## Service & Support in Europe

---

Please contact:

Sharp NEC Display Solutions Europe GmbH.

Landshuter Allee 12-14, D-80637 München

Phone: + 49 (0) 89/99699-0

Fax: + 49 (0) 89/99699-500

For the latest information please see

<https://www.sharpnecdisplays.eu>

Data is subject to change without notice.

## Sales Office List for Asia/Pacific

---

For the latest information please see

<https://www.sharp-nec-displays.com/ap/contact/index.html>