

PAGENETDN

DIGITAL CONTROL

*EclerNet DANTE™/AES67 Paging Station &
Control Touch-Screen*



USER MANUAL

INDEX

1. IMPORTANT REMARK	3
2. IMPORTANT SAFETY INSTRUCTIONS	3
3. IMPORTANT NOTE.....	5
4. INTRODUCTION.....	5
<i>4.1. Main features.....</i>	<i>6</i>
5. INSTALLATION AND CONNECTIONS	7
<i>5.1. Installation and wiring.....</i>	<i>7</i>
<i>5.2. Audio Settings.....</i>	<i>8</i>
6. OPERATION	9
7. LOCAL CONFIGURATION OF THE UNIT	11
<i>7.1. Screen Configuration menu</i>	<i>12</i>
<i>7.2. Device Configuration menu.....</i>	<i>14</i>
<i>7.3. Network Configuration menu.....</i>	<i>15</i>
7.3.1 Factory Preset Network settings	15
<i>7.4. Information / Tools menu.....</i>	<i>16</i>
8. CONNECTION TO A UCP SERVER.....	18
9. PACKAGE CONTENTS	20
10. FUNCTION LIST.....	20
11. FUNCTION DIAGRAM.....	21
12. BLOCKS DIAGRAM	22
13. TECHNICAL FEATURES	23

1. IMPORTANT REMARK



WARNING: SHOCK HAZARD - DO NOT OPEN

AVIS: RISQUE DE CHOC ÉLECTRIQUE - NE PAS OUVRIR



The lightning flash with arrowhead symbol, within an equilateral triangle, is intended to alert the user to the presence of uninsulated “dangerous voltage” within the product’s enclosure that may be of sufficient magnitude to constitute a risk of electric shock to persons.



The exclamation point within an equilateral triangle is intended to alert the user to the presence of important operating and maintenance (servicing) instructions in the literature accompanying the appliance.

WARNING (If applicable): The terminals marked with symbol of “” may be of sufficient magnitude to constitute a risk of electric shock. The external wiring connected to the terminals requires installation by an instructed person or the use of ready-made leads or cords.

WARNING: To prevent fire or shock hazard, do not expose this equipment to rain or moisture..

WARNING: An apparatus with Class I construction shall be connected to a mains socket-outlet with a protective earthing connection.

2. IMPORTANT SAFETY INSTRUCTIONS

1. Read these instructions.
2. Keep these instructions
3. Heed all warnings
4. Follow all instructions
5. Do not use this apparatus near water
6. Clean only with dry cloth
7. Do not block any ventilation openings Install in accordance with the manufacturer’s instructions

8. Do not install near any heat sources such as radiators, heat registers, stoves, or other apparatus (including amplifiers) that produce heat.
9. Do not defeat the safety purpose of the polarized or grounding type plug. A polarized plug has two blades with one wider than the other. A grounding type plug has two blades and a third grounding prong. The wide blade and the third prong are provided for your safety. If the provided plug does not fit into your outlet, consult an electrician for replacement of the obsolete outlet.
10. Protect the power cord from being walked on or pinched particularly at the plugs, convenience receptacles, and at the point where they exit from the apparatus.
11. Only use attachments/accessories specified by the manufacturer.
12. Unplug the apparatus during lightning sorts or when unused for long periods of time.
13. Refer all servicing to qualified personnel. Servicing is required when the apparatus has been damaged in any way, such as power supply cord or plug is damaged, liquid has been spilled or objects have fallen into the apparatus, the apparatus has been exposed to rain or moisture, does not operate normally, or has been dropped.
14. Disconnecting from mains: switching off the POWER switch all the functions and light indicators of the amplifier will be stopped, but fully disconnecting the device from mains is done unplugging the power cord from the mains input socket. For this reason, it always shall remain readily operable.
15. Equipment is connected to a socket-outlet with earthing connection by means of a power cord.
16. The marking information is located at the bottom of the apparatus.
17. The apparatus shall not be exposed to dripping or splashing and that no objects filled with liquids, such as vases, shall be placed on apparatus.
18. This product is for indoor use only.



WARNING: This product must not be discarded, under any circumstance, as unsorted urban waste. Take it to the nearest electrical and electronic waste treatment centre.

NEEC AUDIO BARCELONA, S.L. accepts no liability for any damage that may be caused to people, animal or objects due to failure to comply with the warnings above.

3. IMPORTANT NOTE

Thank you for choosing our **PAGENETDN DANTE™/AES67 Paging Station and EclerNet digital control device.**

It is **VERY IMPORTANT** to carefully read this manual and to fully understand its contents before any connection in order to maximize your use and get the best performance from this equipment.

To ensure optimal operation of this device, we strongly recommend that its maintenance be carried out by our authorized Technical Services.

All ECLER products are covered by warranty, please refer to www.ecler.com or the warranty card included with this product for the period of validity and conditions.

4. INTRODUCTION

PAGENETDN is a programmable Paging Station with dual audio output: DANTE™/AES67 (digital) and analogue (balanced). This way, its control features and its microphone signal can be used for paging together with any EclerNet digital matrix, no matter whether it supports DANTE™/AES67 or not: MIO4040DN, MIMO88, MIMO88SG and MIMO1212SG.

At the same time it shares the same control features as the WPNETTOUCH, and can be programmed to control one or more networked EclerNet devices; it can even control a full installation, a project combining a multitude of different EclerNet devices: MIMO4040DN, MIMO88, MIMO88SG, MIMO1212SG digital matrices, NXA series digital audio managers, DUO-NET PLAYER units, etc. It is fully programmable through the EclerNet Manager application (*).

(*) Refer to the EclerNet Manager Application manual for more information. The EclerNet Manager application is available for download at www.ecler.com.

It comes with a desktop console design, including a gooseneck microphone and a 10" capacitive touch screen panel that can show and manage the User Control Panels for paging and for the control of networked EclerNet devices, VEO video devices and third-party devices.

4.1. Main features

- Digital touchscreen embedded control panel, including the same features as the WPNETTOUCH device:
 - 10.1" IPS display (1280 x 800 pixels)
 - Capacitive & multitouch touch panel
- PoE DC supply compatible
- External power supply compatible: external & universal PSU included + multi-plug AC set
- Ethernet Base-Tx 10/100Mb interface
- Flexo type gooseneck microphone included, XLR connector with safety flap (to avoid microphone unwanted removal)
- Audio transport using DANTE™/AES67, 2 channels:
 - DANTE™/AES67 channel #1 used for microphone signal transmission
 - DANTE™/AES67 channel #2 used for AUX input signal transmission
- Phantom Power available for the MIC input
- MIC out, analogue balanced signal, that makes the PAGENETDN unit compatible for paging in combination with devices that don't support DANTE™/AES67 in a native way, as the MIMO88, MIMO88SG and MIMO1212SG
- AUX input, stereo LINE, RCA connectors. The incoming signal is converted to mono and sent to the network using DANTE™/AES67 channel #2. It can be used to connect an external audio source (like a media player) and inject its signal to the network in DANTE™/AES67 format
- Paging features based on programmable UCP control panels
- EclerNet control device, with the ability to execute EclerNet projects on its internal engine, acting as a server and / or client of UCP panels

5. INSTALLATION AND CONNECTIONS

5.1. Installation and wiring

The unit comes with the paging microphone unmounted, and it must be inserted into the console before using the PAGENETDN for paging purposes.

To install the microphone, gently insert it with the connection pins correctly aligned with the XLR socket in the console (mic's ecler logo facing the back of the unit) and apply some pressure until it clicks, meaning this that the XLR safety flap has been correctly triggered. Once inserted, the microphone will stay in the console with little vertical swaying, thus delivering little handling noise and high robustness feeling.

Whenever it's necessary to extract the microphone from the console, a pin tool must be used to press inside the hole at the back side of the microphone base on the console surface. It will release the XLR safety tap, allowing to draw the microphone, again with some force, to successfully extract it.

Before programming and using it, the PAGENETDN unit must be connected to the network, by means of its internal RJ45 **ETHERNET** interface. This one, and the rest of connectors, are available unscrewing the bottom metal plate of the unit (3 screws must be removed).

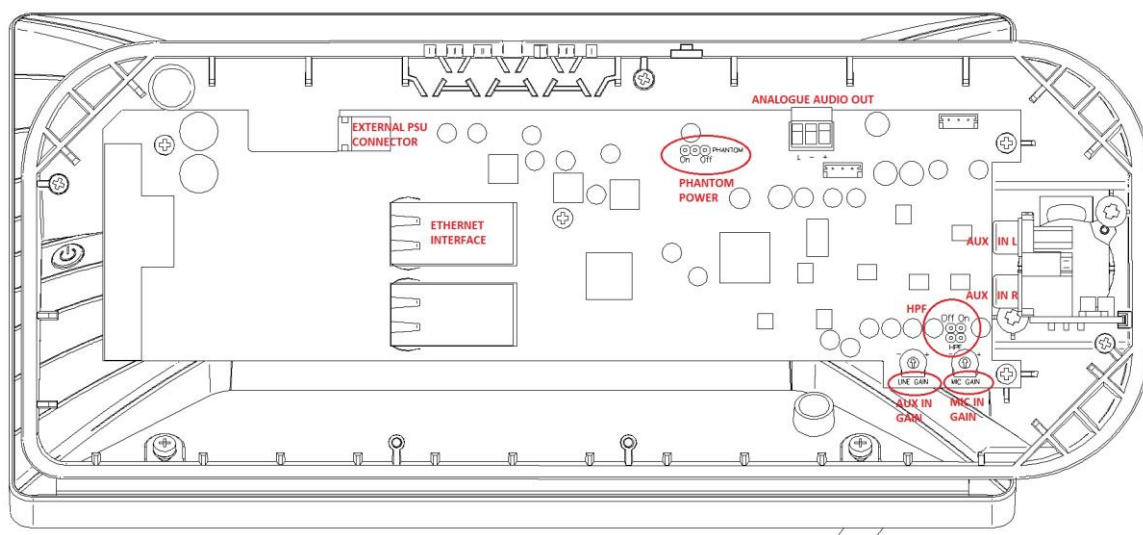

PAGENET internal view, after removing the bottom metal plate

It must as well be supplied with DC Power, directly with PoE (Power over Ethernet), when it is available from the Ethernet switch the unit is connected to, or by means of the included external Power Supply, 12 VDC, 2A (EXTERNAL PSU CONNECTOR).

Additionally, there are 2 extra audio connectors available:

- AUX IN (L / R): stereo LINE input, RCA connectors. The incoming signal is converted to mono and sent to the network using DANTE™/AES67 channel #2. This input can be used to connect an external audio source (like a media player) and inject it's signal to the network in DANTE™/AES67 format
- MIC OUT (ANALOGUE AUDIO OUT): mono balanced signal (Euroblock). It's a copy of the microphone signal in analogue format, that enables to create paging systems in combination with devices without DANTE™/AES67 native support.

5.2. Audio Settings

PAGNETDN has several audio controls in its electronics that can be used to tailor the incoming analogue audio signals:

- PHANTOM POWER ON / OFF (default = ON): it enables or disables the Phantom Power delivered to the microphone XLR connector, in case a condenser microphone is used, like the unit that comes by default with the PAGNETDN device (Ecler eMCN1 model)
- HPF (High Pass Filter) ON /OFF (default = ON): it enables or disables the High Pass Filter (100Hz @ 12dB/oct) applied to the audio signal captured from the microphone capsule, to minimize low frequency and unwanted noise entering into the voice messages path along the audio system
- MIC IN GAIN (*): preamp gain adjustment for the incoming microphone signal. It affects both the resulting DANTE™/AES67 ch #1 output and the ANALOGUE AUDIO (MIC) OUT signal
- AUX IN GAIN (LINE GAIN): preamp gain adjustment for the incoming AUX IN ST LINE signal, later converted to mono and to DANTE™/AES67 ch #2

(*) Note: the microphone XLR connector admits standard XLR microphones to be used, like the Ecler eMCN1 supplied with the unit, but it can't hold those with the base thicker than the standard XLR size:



6. OPERATION

PAGENET must be properly included in an EclerNet project, and configured (regarding DANTE™/AES67 audio routing and / or control features) to finally show the UCP paging and control panels that the end user will have available. Examples:

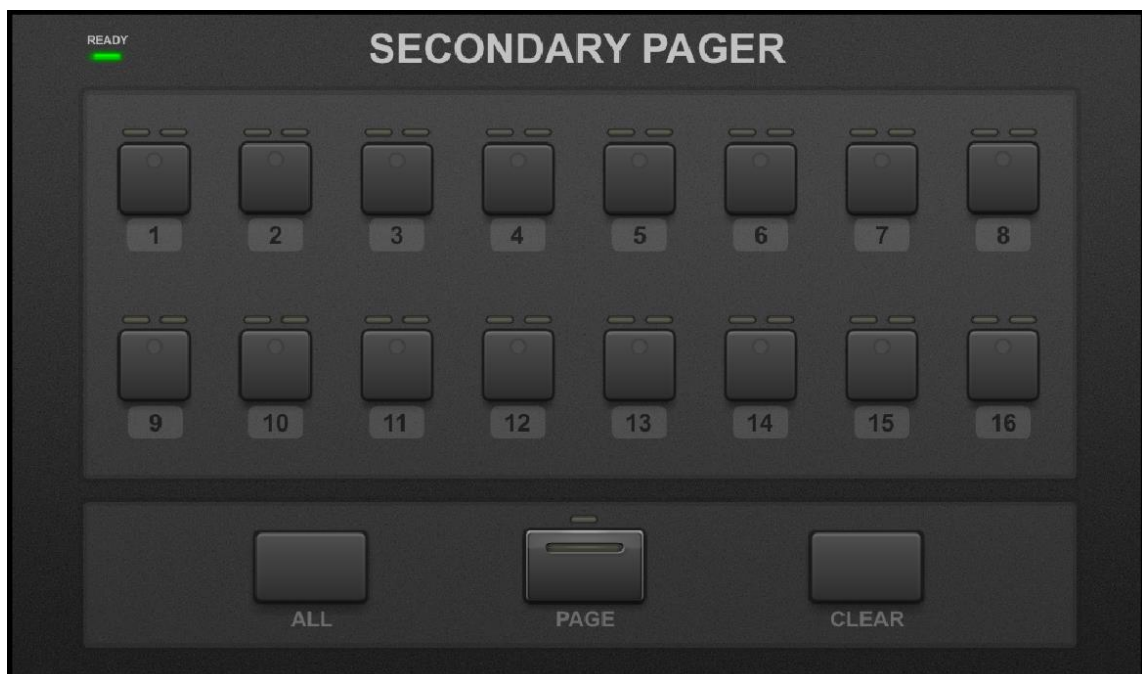

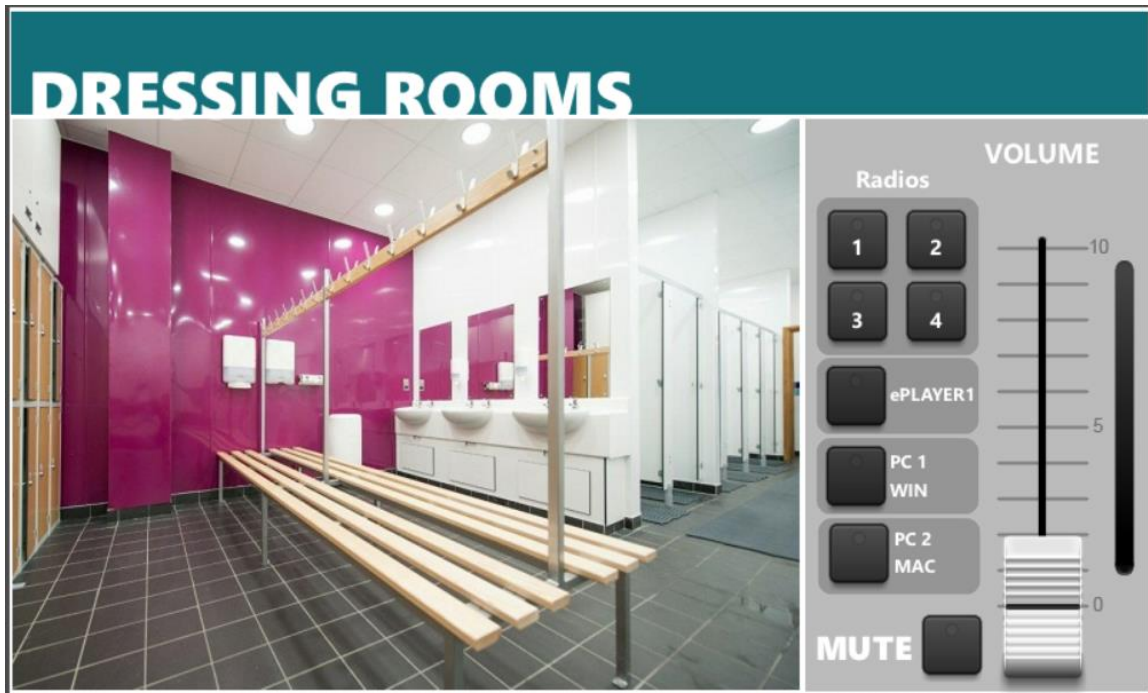

Please, refer to EclerNet Manager application user manual, chapter [PAGENETDN DEVICE](#), for further information.

7. LOCAL CONFIGURATION OF THE UNIT

PAGENETDN settings and configuration menus can be accessed locally from the touch screen of the device itself. These menus are exactly the same as the ones available for the WPNETTOUCH device, as it really includes a WPNETTOUCH unit in it.

The same settings are remotely accessible when the unit is under the control of a remote computer running the EclerNet Manager application.

Local access to the configuration menus can be done by clicking on the SETUP icon, from the home page of the unit:

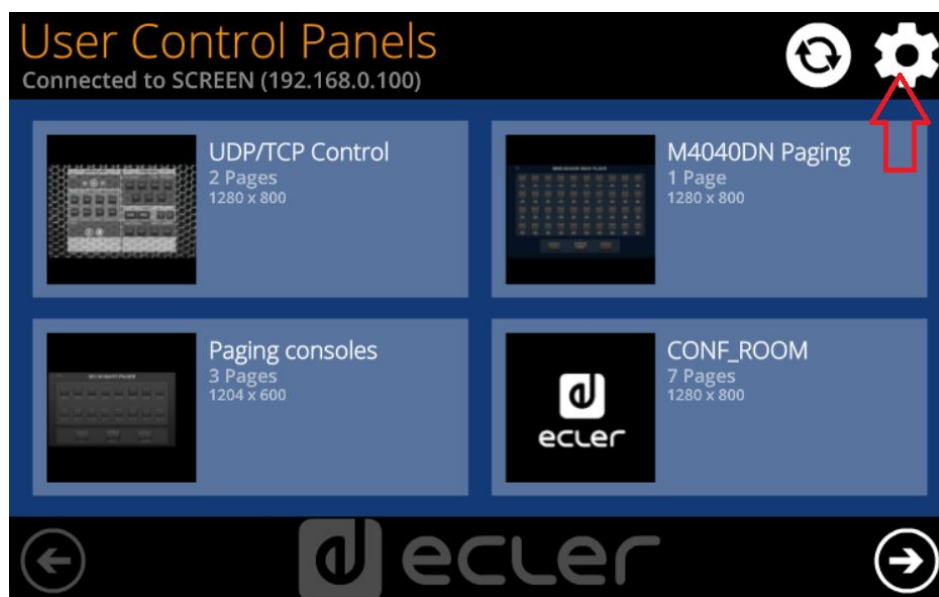

The available configuration menus are the following:

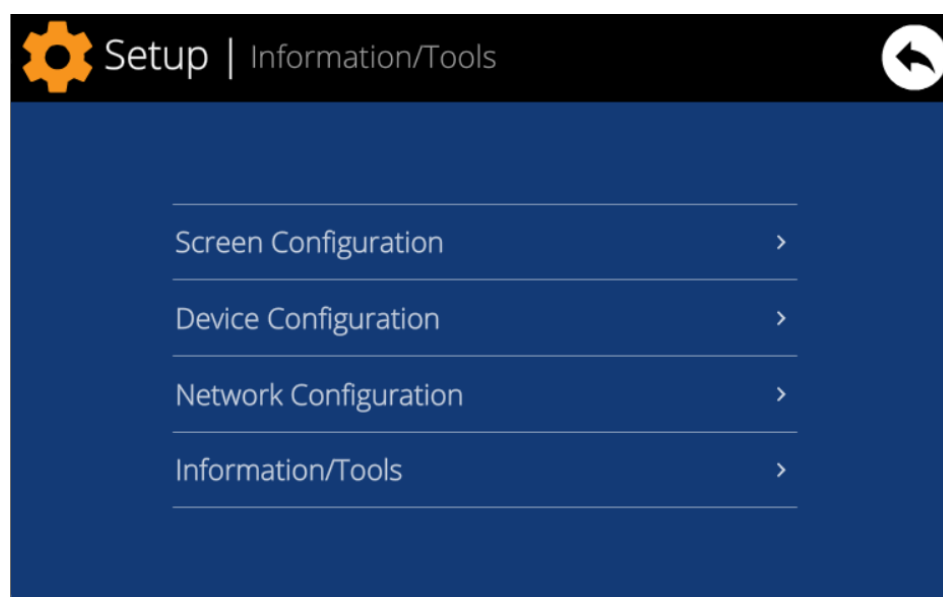

7.1. Screen Configuration menu

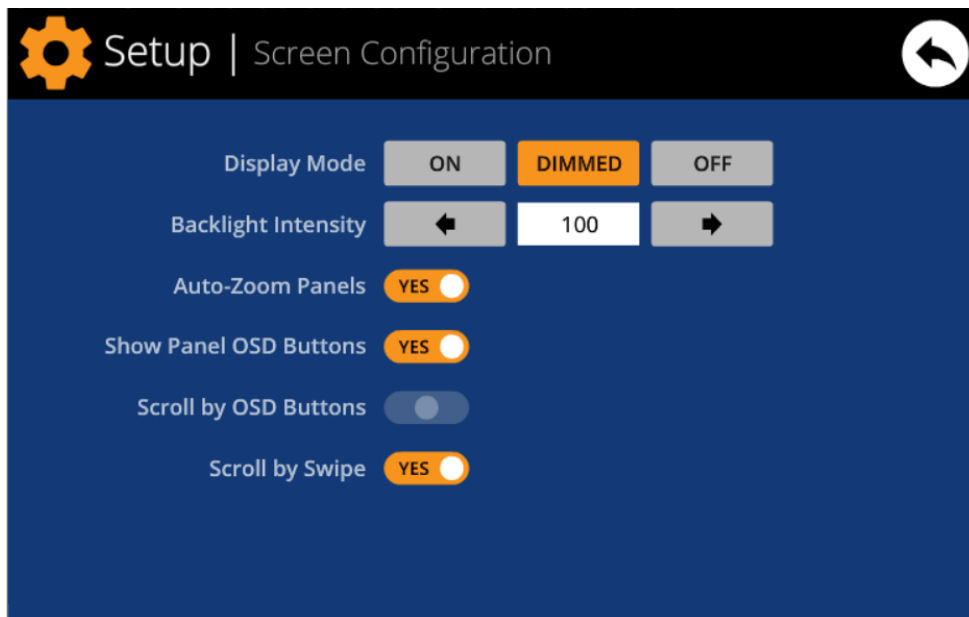

This menu allows setting different parameters affecting the displayed items and controls on the screen of the unit:

- **Display mode:** behavior of the screen dimming in sleep state, after 10 seconds of user inactivity on the touch screen. The available modes are: ON (always lit), DIMMED and OFF (unlit)
- **Backlight Intensity:** brightness intensity of the screen when it is not in sleep mode.
- **Auto-Zoom Panels:** when activated, the graphic control panels (UCPs) are automatically resized to match the maximum visible area, no matter the original resolution they were created in the EclerNet Manager project file

- **Show Panel OSD Buttons:** enables/disables the superimposed display of the navigation buttons in the corners of the displayed UCPs. The top corner buttons can scroll the panel pages (left and right) and the bottom corner buttons access the icon bar:



Note: even when the buttons are not displayed, they can still be active, so that pressing the top corners activates the horizontal scrolling between the panel pages and pressing the bottom corners displays the icon bar. This is an aspect that must be taken into account for the layout of the controls (buttons, sliders, knobs, etc.) on each UCP page during its design; the corners must be as free as possible if these OSD buttons will be used for scrolling between pages (top ones) and always free in the case of the bottom ones (icon bar display).

- **Scroll by OSD Buttons:** enables/disables the scroll action between pages pressing the top corners, even the OSD buttons are hidden
- **Scroll by Swipe:** enables/disables the scroll action between pages with a left or right swipe (press & drag) action on the screen

The icon bar displays new accesses to the horizontal scrolling between the pages of a panel (to the left and right), access to the home page of the unit ("HOME" icon) and exit of the icon bar ("X" icon):

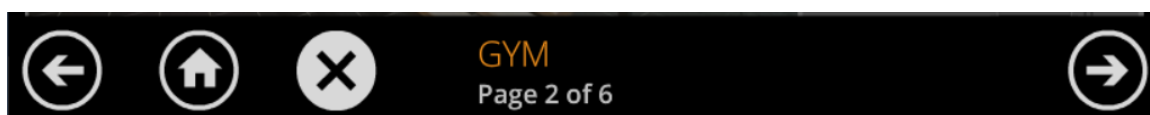

7.2. Device Configuration menu

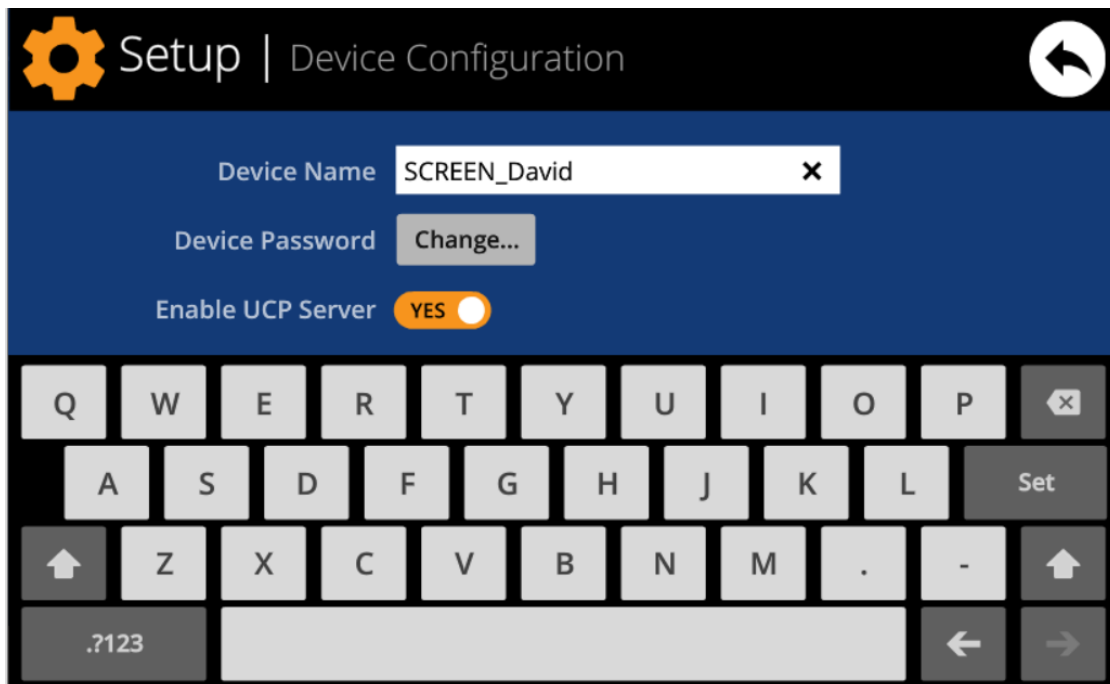

This menu allows adjusting the following parameters of the unit:

- **Device Name:** name of the device, as seen from other WPNETTOUCH / WPmSCREEN devices, as well as from the EclerNet Manager application
- **Device Password:** password for the protection of the device against the editing of its critical configuration parameters, requested for this purpose if enabled (enabled = other than blank password)
- **Enable UCP Server:** enables/disables the embedded UCP server service of the unit
 - **Enabled:** the EclerNet project stored in the unit (“Local Project”) will be fully functional, taking control of the hardware devices that are included in it (MIMO4040DN, MIMO88, NXA units, etc.) and serving the UCP panels it contains to potential UCP clients on the network
 - **Disabled:** the EclerNet Local Project is deactivated, releasing the control over all included hardware (MIMO4040DN, MIMO88, NXA units, etc.) and, consequently, also ceasing to serve UCPs for clients

Warning: In the disabled status, another device or computer running a project containing all or some of the hardware devices existing in the WPNETTOUCH's Local Project could take control of them. **Just one device and project can take control of the same hardware device at the same time**, so that units controlled by a device must first be released before trying to control them from another device:

- From EclerNet Manager, you can release the devices controlled by the computer through the creation of a new project (File -> New Project), or by disconnecting them from the network one by one (right mouse button -> Disconnect)
- From a WPNETTOUCH / WPmSCREEN, you can release the devices controlled by the unit by setting the Enable UCP Server option on NO.

7.3. Network Configuration menu

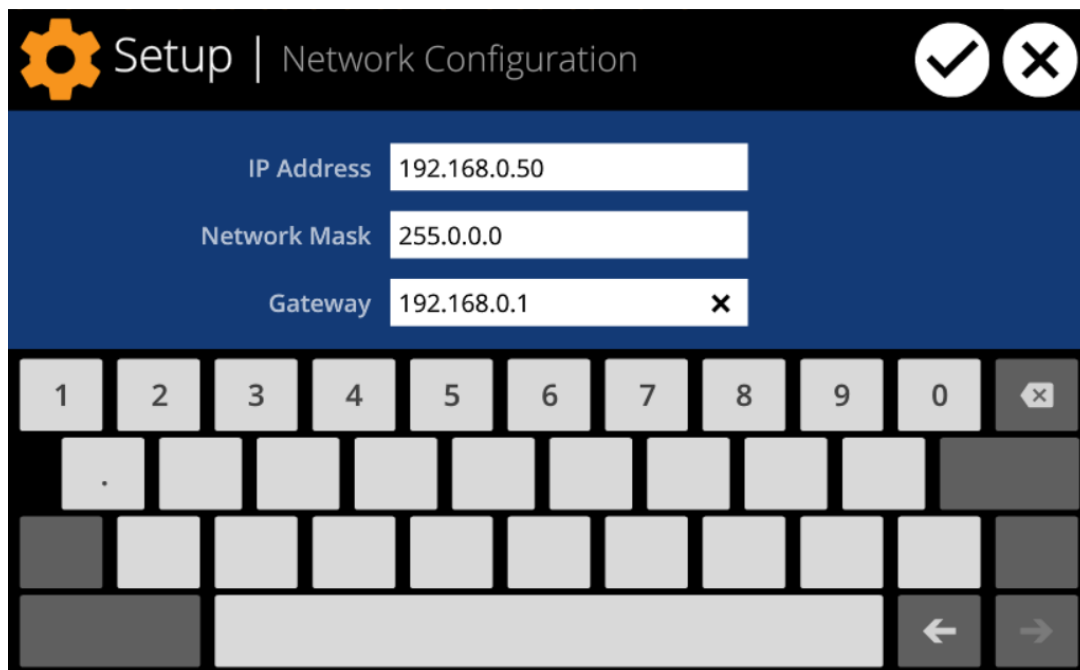

This menu allows modifying the network connection parameters of the WPNETTOUCH unit: IP address, network mask and gateway.

Note: neither the WPNETTOUCH nor any other EclerNet device supports the protocol of dynamic allocation of IP addresses (Dynamic Host Configuration Protocol, or DHCP), so it's always necessary to manually assign them static addresses

7.3.1 Factory Preset Network settings

The factory default network settings for EclerNet Manager compatible devices are as follows:

- IP: 192.168.0.100
- Mask: 255.255.255.0
- Gate: 192.168.0.1
- UDP Port: 2210

7.4. Information / Tools menu

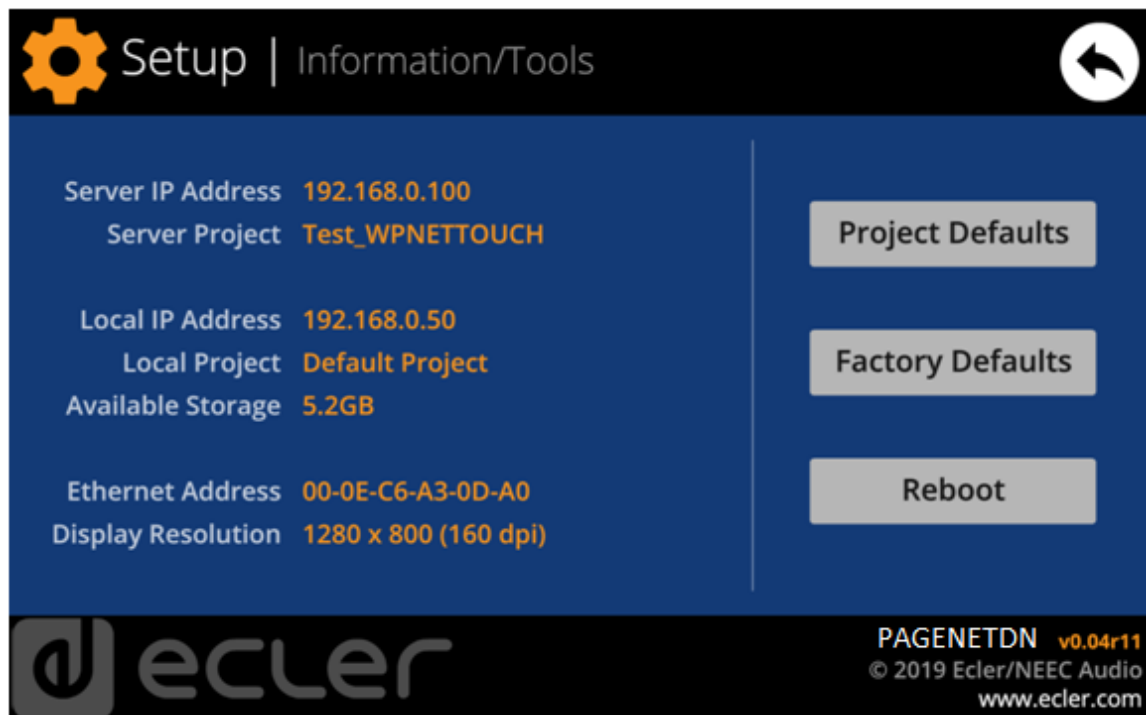

This menu displays the following information:

- **Server IP Address:** IP address of the UCP server device that the unit is connected to, as a UCP client. When the unit is connected to itself as a client, it will show its own IP address (= Local IP Address)
- **Server Project:** name of the project running in the server the unit is connected to as a UCP client (project running on the UCP server of the client)
- **Local IP Address:** IP Address configured for the WPNETTOUCH unit
- **Local Project:** name of the project stored in the internal storage space of the WPNETTOUCH unit. This project can be uploaded to the WPNETTOUCH unit using EclerNet Manager software app
- **Available Storage:** internal storage space available to upload a project file, which would include User Control Panels data and graphics
- **Ethernet Address:** MAC address of the NIC (network interface card) mounted in the WPNETTOUCH unit
- **Display resolution:** native screen resolution of the IPS panel of the unit (1280 x 800)
- **Firmware version:** shown at the lower right hand side corner (in the above example v0.04r11)

And the following restore / reboot options:

- **Project Defaults:** clears the project in memory, replacing it with a blank project, after warning that the process is irreversible:



Project Defaults

Warning: this action will replace the current project with a default (blank) one, losing all the configuration and user data in the current project. Are you sure?

- **Factory Defaults:** clears the entire configuration and all data in the unit, restoring the factory default settings, after warning that the process is irreversible:



Factory Defaults

Warning: this action will bring back this device to its factory defaults. This involves losing your current network configuration, general setup and current project data. Are you sure?

- **Reboot:** reboots the unit:



Reboot

This action will reboot this device, losing network connection for a while and recovering normal performance after the reboot. Are you sure?

8. CONNECTION TO A UCP SERVER

From the home screen of the unit, the connection icon on the upper side of the screen will give access to the Connection page:



This page allows deciding the UCP server the unit will connect to as a client. The UCP server may be a computer, a MIMO4040DN matrix (yes, it has an embedded UCP server in its engine!) another WPNETTOUCH / WPmSCREEN unit or even the same PAGENETDN / WPNETTOUCH unit. In any case, the UCP server shall host and run an EclerNet Manager project that includes a series of UCPs which can be remotely managed by any UCP client.

It is possible to directly enter the IP address of the server device, using the touch keyboard displayed on the screen, or to select a device from a list of automatically detected server devices, which is accessed by clicking on the grey button with the list icon to the right of the "Connect" button:

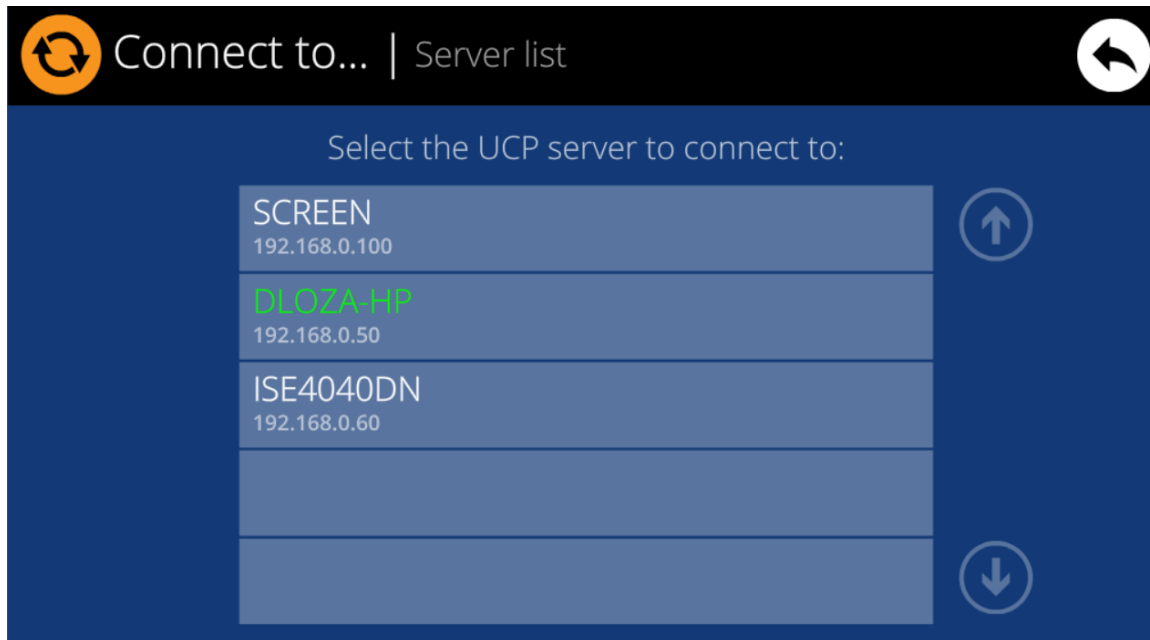

Note: in the list of detected server devices, the name of the WPNETTOUCH unit under control will appear in green (the one matching with the Local IP Address)

After selecting a server unit or an IP address, using either of these two methods, pressing the "Connect" button will confirm the selection and start the process of connecting to the server. If this process is successful, the UCPs that the server makes available for the WPNETTOUCH client will appear on the screen:

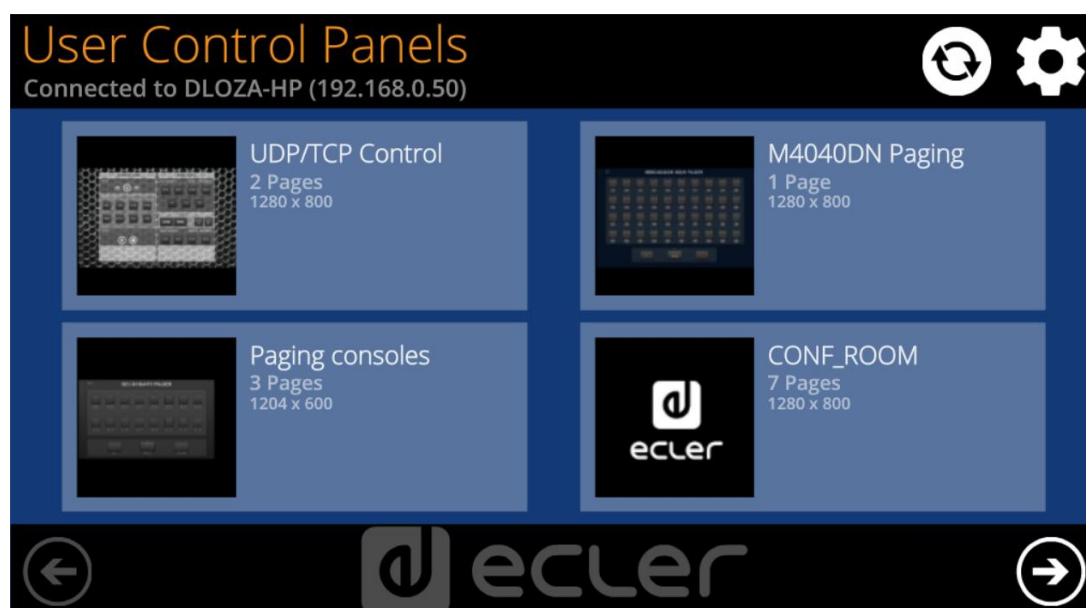

9. PACKAGE CONTENTS

- PAGENETDN unit
- Gooseneck microphone + anti-pop screen
- External PSU, 24V – 12A, universal, multi AC plug
- Euroblock 3p aerial connector
- Quick User Guide and Warranty Card

10. FUNCTION LIST

1. Multi-touch screen
2. Gooseneck Microphone
3. XLR connector
4. Power cord hole

11. FUNCTION DIAGRAM

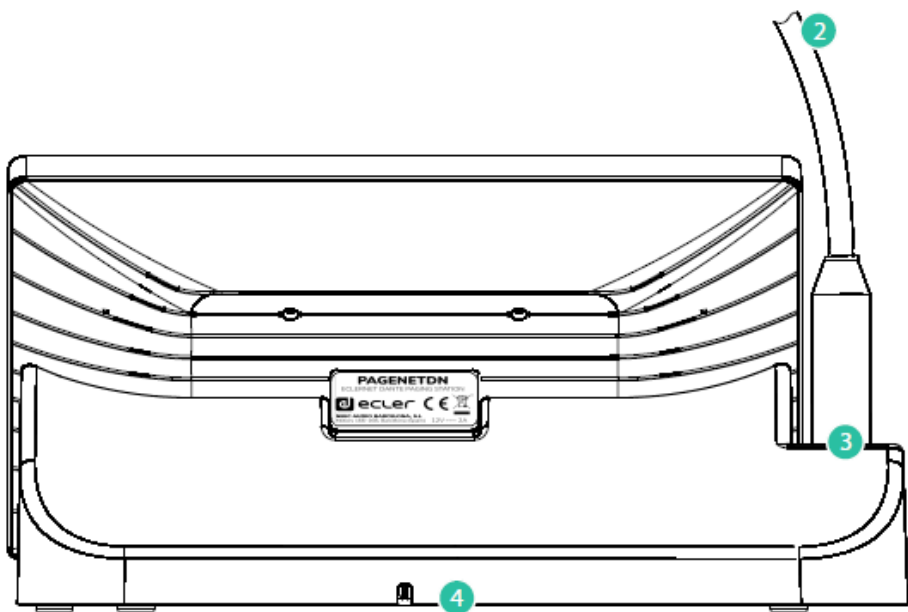
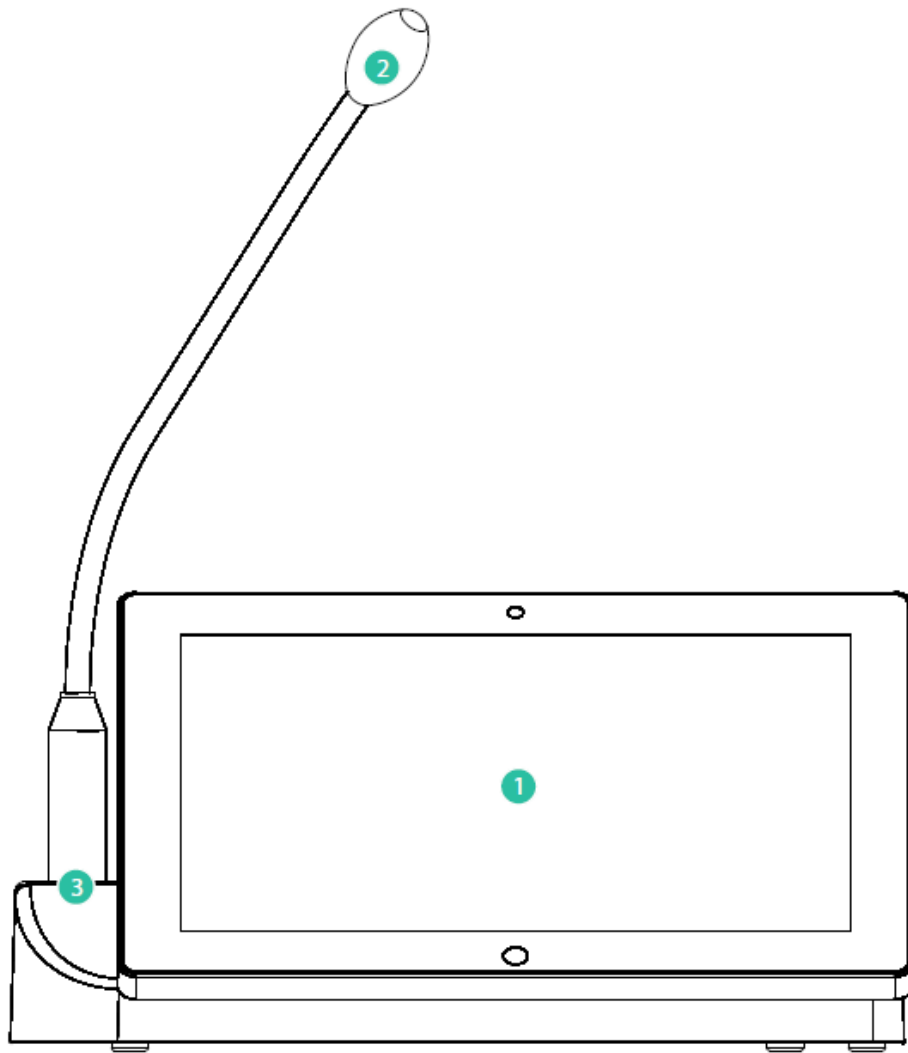

12. BLOCKS DIAGRAM

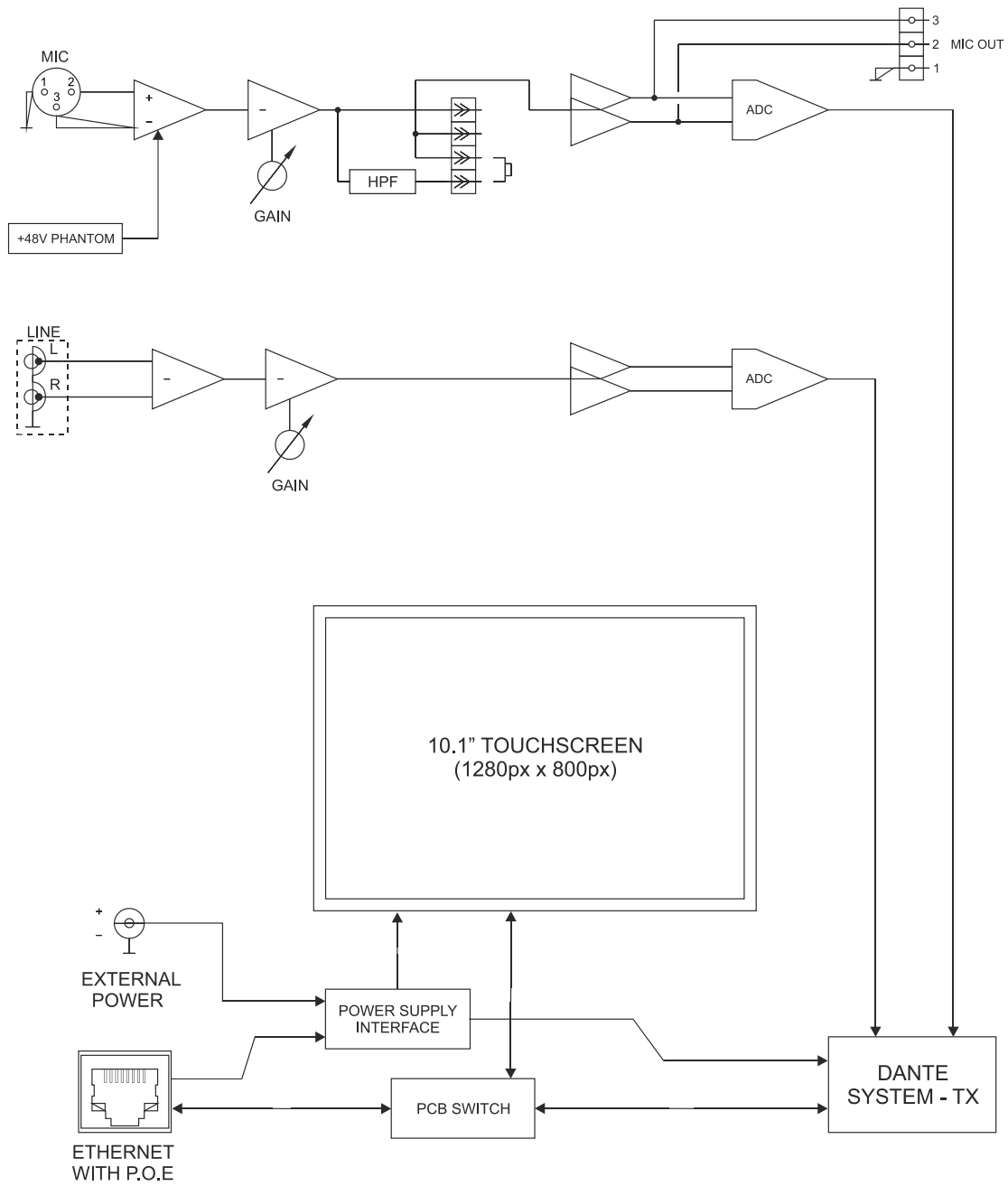

13. TECHNICAL FEATURES

MIC INPUT	
Microphone type	Removable gooseneck condenser microphone (eMCN1)
Polar pattern	Unidireccional
Microphone freq. response	50Hz – 18kHz (-10dB)
Phantom Voltage	48VDC, ON/OFF by internal JUMPER
Output level with eMCN1 MICROPHONE	-5dBV @ 94dB SPL with ADJ MAX. -10dBV @ 94dB SPL with ADJ MID.
HPF	-20dBV @ 94dB SPL with ADJ MIN. 100Hz 12dB/oct ON/OFF by internal JUMPER
LINE INPUT	
Connector	RCA
Signal	Line level, L + R
Nominal input level	-10dBV
Gain adjust	-20dBV / 0dBV
Input impedance	>10kΩ
DANTE™/AES67 AUDIO INTERFACE	
DANTE™/AES67 Network Tx channels	2
Latency	1 / 2 / 5 ms (selectable)
Connector	RJ45
AUDIO OUTPUTS	
Microphone output signal Connector	Balanced, analog
Output level	Phoenix connector (symmetric) 0dBV
System	
CPU	RK3128 quad core processor, clocked 1.6G
RAM	1GB
ROM	8GB
Screen	
Size	10,1" IPS
Resolution	1280x800
Contrast ratio	1300
Brightness	300cdm2
Screen scale / Display area	16:9 / 218x135mm
Backlight	LED
Touch-panel	Capacitive multi-touch
Network & Connectivity	
Ethernet	Supports PoE
Ethernet port	Ethernet Base-Tx 10/100Mb / 1GB CAT5e or better up to 100m.
Power	
External power supply voltage	12VDC
Maximum power consumption	12W from 12V External Power Supply Voltage 15W from PoE PoE: class 0 802.3af Poe PD compliant
Mains Voltage	100-240VAC + External PSU 12VDC

General	
Dimensions (microphone excluded (WxHxD))	295x155x135 mm / 11.6"x6.1"x5.3"
Weight	1.5 kg / 3.3 lbs
AC Power Adapter	100-240VAC 47-63Hz 12V / 2A
Accessories included	
AC power adapter	100-240VAC 47-63Hz 12V / 1.5A, multiplug
Microphone	Ecler eMCN1



All product characteristics are subject to variation due to production tolerances. **NEEC AUDIO BARCELONA S.L.** reserves the right to make changes or improvements in the design or manufacturing that may affect these product specifications.

For technical queries contact your supplier, distributor or complete the contact form on our website, in [Support / Technical requests](#).

Motors, 166-168 08038 Barcelona - Spain - (+34) 932238403 | information@ecler.com | www.ecler.com