

Wireless Presentation System

HS-2

Instruction Manual



■ IMPORTANT SAFEGUARDS

Make sure to read the “IMPORTANT SAFEGUARDS” in this guide before using this product.

■ Read Instructions

All the safety and operating instructions should be read before the appliance is operated.

■ Retain Instructions

The safety and operating instructions should be retained for future reference.

■ Heed Warnings

All warnings on the product and in the operating instructions should be adhered to.

■ Follow Instructions

All operating and use instructions should be followed.

■ Cleaning

Unplug this product from the wall outlet before cleaning. Do not use liquid cleaners or aerosol cleaners. Use a damp cloth for cleaning.

■ Attachments

Do not use attachments not recommended by the product manufacturer as they may cause hazards.

■ Water and Moisture

Do not use this product near water - for example, near a bath tub, wash bowl, kitchen sink, or laundry tub, in a wet basement, or near a swimming pool, and the like.

■ Placement

Do not place this product on an unstable cart, stand, tripod, bracket, or table. The product may fall, causing serious injury to a child or adult, and serious damage to the product. Use only with a cart, stand, tripod, bracket, or table recommended by the manufacturer, or sold with the product. Any mounting of the product should follow the manufacturer's instructions, and should use a mounting accessory recommended by the manufacturer.

Do not place the following items near the air exhaust vent on the bottom as warm air blows out from the exhaust vent:

- Spray cans (Heat may increase the pressure inside the can and may cause an explosion.)
- Metals (They may become hot and may cause an accident or injury.)
- Houseplants and pets
- Items that are deformed or adversely affected by heat

■ Ventilation

Slots and openings in the cabinet are provided for ventilation and to ensure reliable operation of the product and to protect it from overheating, and these openings must not be blocked or covered. The openings should never be blocked by placing the product on a bed, sofa, rug, or other similar surface. This product should not be placed in a built-in installation such as a bookcase or rack unless proper ventilation is provided or the manufacturer's instructions have been adhered to.

■ During use and immediately after use, do not touch anywhere near the air exhaust vent on the bottom as they may become hot and may cause burns.

■ Power Sources

This product should be operated only from the type of power source indicated on the marking label. If you are not sure of the type of power supply to your home consult your appliance dealer or local power company.

■ Grounding or Polarization

This product may be equipped with either a polarized 2-wire AC line plug (a plug having one blade wider than the other) or a 3-wire grounding type plug, a plug having a third (grounding) pin. If the 2-Wire polarized plug will not fit in the outlet, try reversing the plug. If the plug still fails to fit, contact your electrician to replace your obsolete outlet. Do not defeat the safety purpose of the polarized plug. The 3-wire grounding type plug will fit into a grounding type power outlet. This is a safety feature. If you are unable to insert the plug into the outlet, contact your electrician to replace your obsolete outlet. Do not defeat the safety purpose of the grounding type plug.

■ Power-Cord Protection

Power-supply cords should be routed so that they are not likely to be walked on or pinched by items placed upon or against them, paying particular attention to cords at plugs, convenience receptacles, and the point where they exit from the product.

■ Lightning

For added protection for this product during a lightning storm, or when it is left unattended and unused for long periods of time, unplug it from the wall outlet and disconnect the antenna or cable system. This will prevent damage to the product due to lightning and power-line surges.

■ Overloading

Do not overload wall outlets, extension cords, or integral convenience receptacles as this can result in a risk of fire or electric shock.

■ A product and cart combination should be moved with care. Quick stops, excessive force, and uneven surfaces may cause the product and cart combination to overturn.



■ Object and Liquid Entry

Never push objects of any kind into this product through openings as they may touch dangerous voltage points or short-out parts that could result in a fire or electric shock. Never spill liquid of any kind on the product.

■ Servicing

Do not attempt to service this product yourself as opening or removing covers may expose you to dangerous voltage or other hazards. Refer all servicing to qualified service personnel.

■ Damage Requiring Service

Unplug this product from the wall outlet and refer servicing to qualified service personnel under the following conditions:

- When the power-supply cord or plug is damaged.
- If liquid has been spilled, or objects have fallen into the product.
- If the product has been exposed to rain or water.
- If the product does not operate normally by following the operating instructions. Adjust only those controls that are covered by the operating instructions as an improper adjustment of other controls may result in damage and will often require extensive work by a qualified technician to restore the product to its normal operation.
- If the product has been dropped or damaged in any way.
- When the product exhibits a distinct change in performance - this indicates a need for service.

■ Replacement Parts

When replacement parts are required, be sure the service technician has used replacement parts specified by the manufacturer or have the same characteristics as the original part. Unauthorized substitutions may result in fire, electric shock or other hazards.

■ Safety Check

Upon completion of any service or repairs to this product, ask the service technician to perform safety checks to determine that the product is in proper operating condition.

■ Heat

The product should be situated away from heat sources such as radiators, heat registers, stoves, or other products (including amplifiers) that produce heat.

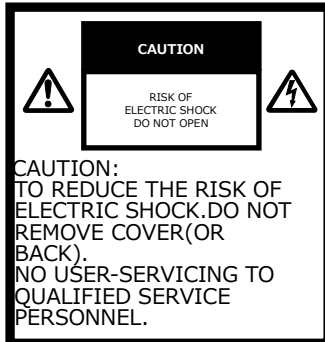

The lightning flash with arrowhead symbol, within an equilateral triangle, is intended to alert the user to the presence of uninsulated "dangerous voltage" within the product's enclosure that may be of sufficient magnitude to constitute a risk of electric shock to persons.



The exclamation point within an equilateral triangle is intended to alert the user to the presence of important operating and maintenance (servicing) instructions in the literature accompanying the product.

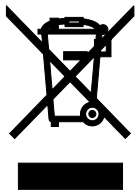

This symbol [crossed-out wheeled bin WEEE Annex IV] indicates separate collection of waste electrical and electronic equipment in the EU countries.

Please do not throw the equipment into the domestic refuse. Please use the return and collection systems available in your country for the disposal of this product.

WARNING

TO REDUCE THE RISK OF FIRE OR ELECTRIC SHOCK, DO NOT EXPOSE THIS PRODUCT TO RAIN OR MOISTURE.

The connection of a non-shielded equipment interface cable to this equipment will invalidate the FCC Certification or Declaration of this device and may cause interference levels which exceed the limits established by the FCC for this equipment. It is the responsibility of the user to obtain and use a shielded equipment interface cable with this device. If this equipment has more than one interface connector, do not leave cables connected to unused interfaces. Changes or modifications not expressly approved by the manufacturer could void the user's authority to operate the equipment.

FOR UNITED STATES USERS: INFORMATION

This equipment has been tested and found to comply with the limits for a Class B digital device, pursuant to Part 15 of the FCC Rules. These limits are designed to provide reasonable protection against harmful interference when the equipment is operated in a commercial environment.

This equipment generates, uses, and can radiate radio frequency energy and, if not installed and used in accordance with the instruction manual, may cause harmful interference to radio communications. Operation of this equipment in a residential area is likely to cause harmful interference in which case the user will be required to correct the interference at his own expense.

USER-INSTALLER CAUTION:

Your authority to operate this FCC verified equipment could be voided if you make changes or modifications not expressly approved by the party responsible for compliance to Part 15 of the FCC rules.

■ BEFORE YOU USE

- Be sure to use the cable supplied with the product.
- The supplied power cord and AC adapter are designed for exclusive use with this product. Do not use them with other products.
- Be sure to use the power cord applicable to your local power specifications. If the product was sold in Japan, use the AC adapter sold with the product with 100 VAC and 50 or 60 Hz.
- When storing the product, do not leave it under direct sunlight or by heaters. It may be discolored, deformed, or damaged.
- Do not place this product in any humid, dusty, salt bearing wind, or vibrating locations. Use it under the following environmental conditions:
Temperature : 0°C ~ 40°C
Humidity : 30% ~ 85% (No condensation)
- Use a soft, dry cloth for cleaning. Do not use any volatile solvent such as thinner or benzene.
- Follow the guidelines below to prevent the unit from dropping or overturning.
 - Use the product on a stable base, desk, or table. Do not place the product on an unstable base or slanted location.
 - Place or wire the product so as to prevent the cables from being pulled or drawn.
- If this product is used for longer than the warranty period, its performance and quality may deteriorate due to the lifetime of its parts. For parts replacement (on chargeable basis), consult the dealer from whom you purchased this product or our branch/office near your location.
- Battery precautions
 - If this product is not going to be used for a long time, take the batteries out of the remote control.
 - Do not use rechargeable batteries.
 - Do not try to recharge or short-circuit the batteries.
 - When disposing of used batteries, follow the instructions of your local government.
 - Insert from one side and pay particular attention to the polarity (+/- directions).
 - Children may ingest small batteries; always keep batteries safe and out of reach.
 - If a battery is swallowed, consult a doctor immediately as this could result in asphyxiation or be an obstacle to digestion, etc.
 - If any liquid from a battery leaks onto your skin or clothes, flush the area with clean water immediately. If it gets into your eye, flush immediately with clean water and then contact a doctor.
- Copyright
Unless used for personal use, it is prohibited strictly under copyright law to use any photo files without the prior consent of the copyright holder. Even if using for personal use, be careful that there could be a situation where video or audio recording is restricted or illegal.
- The contents of this document are subject to change without notice. The latest version is available from the following official website:
<https://www.elmousa.com>
<https://www.elmoeurope.com>
- It is prohibited under copyright law to use or copy any part or the whole of this document without our prior written consent.
- ELMO shall not be liable for any claim for damage or loss of earnings or any claim raised by a third person due to the use, malfunction or repair of this product.

■ TABLE OF CONTENTS

■ IMPORTANT SAFEGUARDS	1
■ BEFORE YOU USE	4
■ TABLE OF CONTENTS	5
① PREPARATION	7
◆ PACKAGE CONTENTS	7
② PART NAMES AND FUNCTIONS	8
◆ NAME OF EACH PART	8
◆ OPERATING PANEL	9
◆ FRONT PANEL	10
◆ REAR PANEL	11
◆ FIXING HS-2 TO A DESK	13
◆ ABOUT THE FAN	13
③ BASIC OPERATIONS	14
◆ CONNECTING TO A PROJECTOR OR MONITOR	14
◆ CONNECTING TO A POWER SOURCE	14
◆ POWER ON/OFF	15
◆ SETTING THE DESTINATION	15
◆ INSERTING BATTERIES TO THE REMOTE CONTROL	15
④ USING THE HS-2	16
■ Hs2Display (Display app)	16
◆ CONNECTING	16
◆ OPERATING THE HS-2	19
◆ RECORDING	22
◆ AUDIO OUTPUT	23
⑤ ADVANCED OPERATIONS	25
■ HOME SCREEN	25
◆ LIST OF APPS	26
■ PAINT	27
◆ DRAWING ON THE SCREEN	28
■ BROWSER	29
■ FILE	29
◆ SELECTING THE FILE	29
■ VIDEO CONFERENCE APP (EZT)	30
■ ELMO Play	30
◆ INSTALLING AN APP	30
◆ UNINSTALLING AN APP	30
⑥ CONFIGURING THE SETTINGS	31
◆ SETTINGS SCREEN	31
◆ CONNECTING TO THE NETWORK	34
◆ NETWORK PROXY SETTINGS	36

◆PAIRING OF THE REMOTE CONTROL.....	37
◆RESOLUTION OF THE MONITOR	38
◆DATE AND TIME SETTINGS.....	38
◆KEYBOARD SELECTION	39
◆APP SELECTION	39
⑦ FAQ (Frequently asked questions and answers).....	40
⑧ TROUBLESHOOTING	45
◆SYMPTOMS AND SOLUTIONS	45
⑨ SPECIFICATIONS.....	47
◆VIDEO INPUT.....	48
◆VIDEO OUTPUT.....	49
◆VIDEO RECORDING.....	49
◆STILL IMAGE RECORDING.....	49
◆LIST OF SUPPORTED MEDIA TYPES	50
◆SYSTEM REQUIREMENTS	50
■ TRADEMARKS AND LICENSES	51

1 PREPARATION

◆ PACKAGE CONTENTS

The items below are included with the product. If any item is missing, contact the dealer from whom you purchased the product.

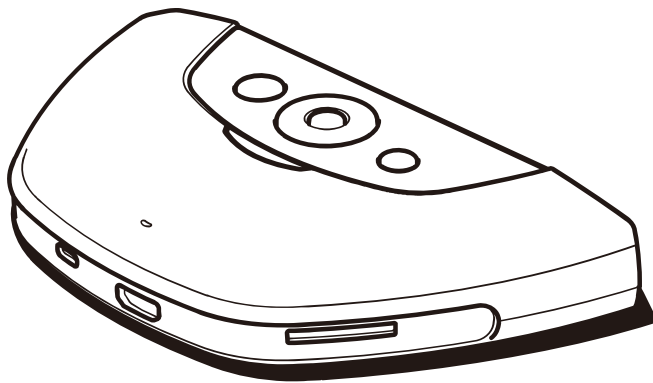

HS-2 (Main unit)

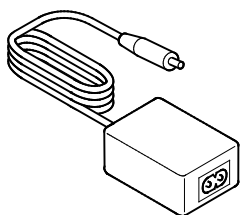

AC adapter

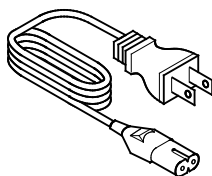

Power cable

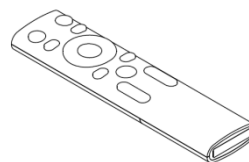

Remote control

※Batteries are not included in the package.
Please use AAA batteries.

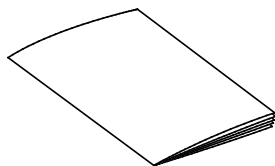

Quick Start Guide

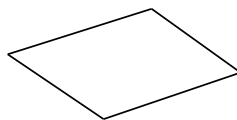

Warranty Card
(For Japan/ North
America only)

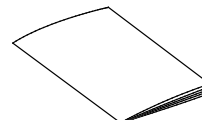

IMPORTANT SAFEGUARDS

2 PART NAMES AND FUNCTIONS

◆NAME OF EACH PART

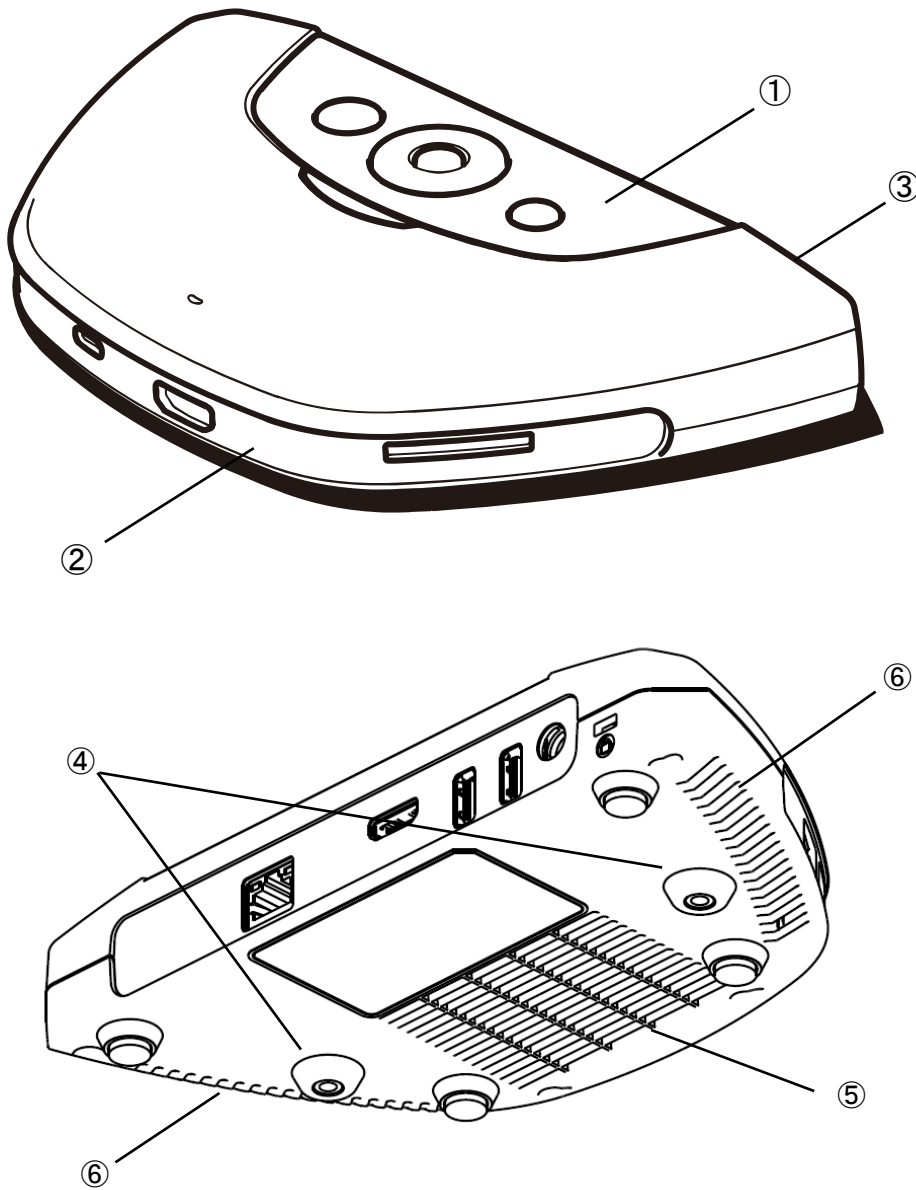

	Name	Function
①	Operating panel	⇒P.9
②	Front panel	⇒P.10
③	Rear panel	⇒P.11
④	Fixing screw holes	⇒P.13
⑤	Intake vent	
⑥	Exhaust vent	

※The HS-2 has a built-in cooling fan.

◆ OPERATING PANEL

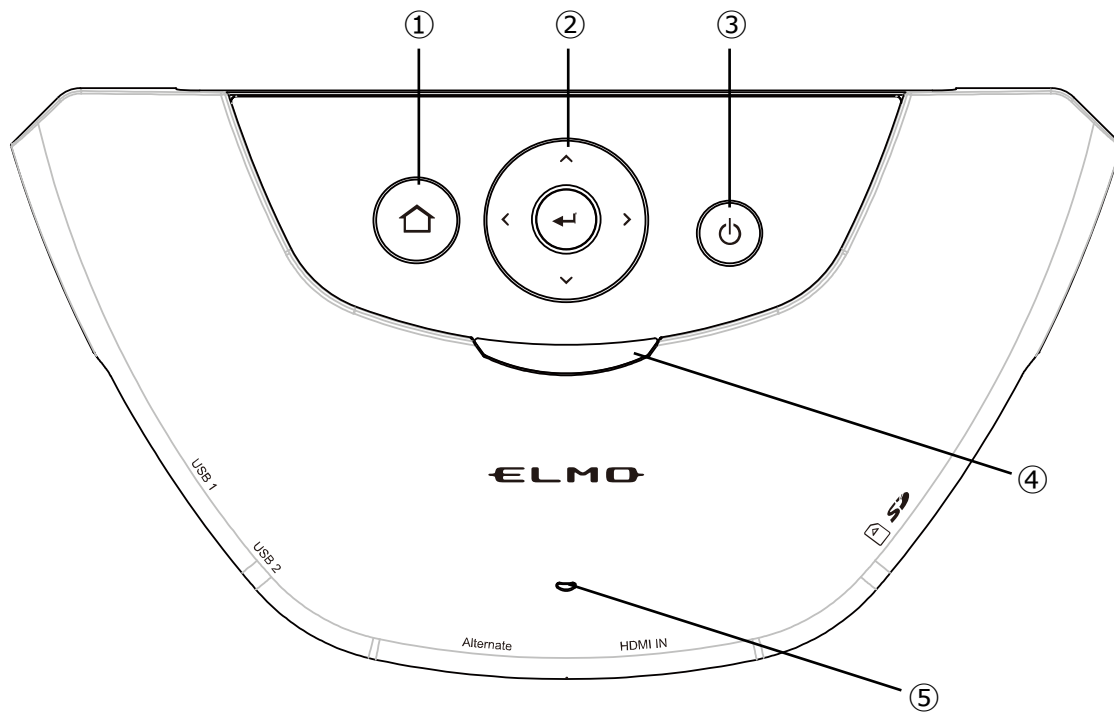

Mark	Name	Function
①	Home button	To go to the Home screen.
②	D-pad / Enter button	Up/Down/Left/Right buttons : To move the cursor in the direction of the arrow. Enter button: To decide operation.
③	Power button	To turn ON/OFF the HS-2. Press once: To turn ON. (Power LED: lights up blue) Press again: To turn OFF. (Power LED: lights up red)
④	Power LED	To indicate the status of the HS-2. Flashing red: Starting Solid red: Standby Solid blue: In operation
⑤	Built-in microphone	To be used as an audio source for recording and video conference.

◆ FRONT PANEL

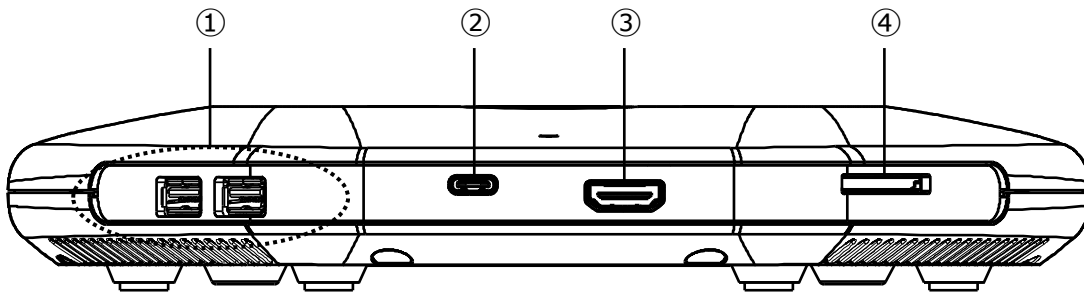

	Name	Function
①	USB2.0 ports [Type-A]	To connect a USB device [USB2.0] such as a mouse, USB flash drive, USB camera, microphone, and speaker.
②	USB Type-C Input port [DisplayPort Alternate]	To connect a device with USB Type-C port (such as Mac, Chromebook, and Windows that supports DisplayPort Alternate (Alt) mode) for image input. ※Use a USB Type-C cable that supports DisplayPort Alternate (Alt) mode.
③	HDMI Input port [Type-A]	To connect a device with HDMI Type-A port (such as a computer and document camera) for image input.
④	SD card slot	To insert the SD card or SDHC card (Class 10 or higher) for image recording or file playback.

◆ REAR PANEL

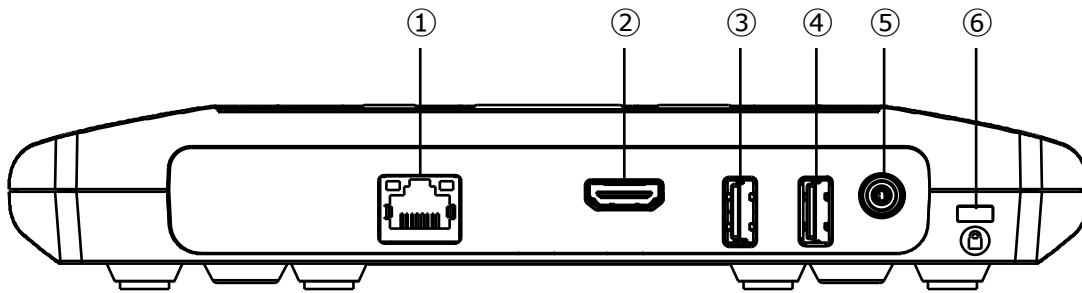

	Name	Function
①	LAN port [RJ45]	To connect a LAN cable to access the external network. (For web browsing, video watching, etc.)
②	HDMI Output port [Type-A]	To connect a device with HDMI Type-A port (such as a monitor and projector) for image output.
③	USB3.0 port [Type-A]	To connect a USB device [USB3.0] such as a mouse, USB flash drive, USB camera, microphone, and speaker.
③	USB2.0 port [Type-A]	To connect a USB device [USB2.0] such as a mouse, USB flash drive, USB camera, microphone, and speaker.
⑤	DC IN 12V	To connect the supplied AC adapter.
⑥	Security slot	To connect a security wire. Use this slot when installing in a classroom to prevent theft.

◆REMOTE CONTROL

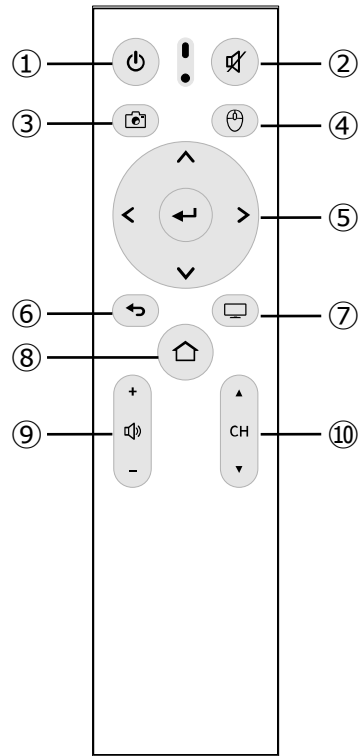

Mark	Name	Function
①	Power button	To turn ON/OFF the HS-2.
②	Mute button	To turn ON/OFF the audio output. You can switch between mute and unmute by pressing this button.
③	Capture button	To capture a still image. ※This function is available only on the Home screen or Hs2Display screen.
④	Cursor button	When this button is pressed the cursor appears. The cursor disappears when this button is pressed again. Move the cursor to an icon and press the Enter button to operate.
⑤	D-pad / Enter button	Up/Down/Left/Right buttons : To move the cursor in the direction of the arrow. Enter button: To decide operation.
⑥	Return button	To return to the previous screen.
⑦	Hs2Display	To display Hs2Display screen. ※This function is available only on the Home screen.
⑧	Home button	To go to the Home screen.
⑨	Volume button	To adjust the volume. (+: increase -: decrease)
⑩	Channel button	To switch the channel of the image to be input to HS-2. ※This function is available only on the Hs2Display screen.

◆FIXING HS-2 TO A DESK

When fixing the HS-2 to a desk, use M4 screws (pitch 0.5 mm) with a length that allows you to insert 5 mm from the bottom of the main unit.

■Securing unit

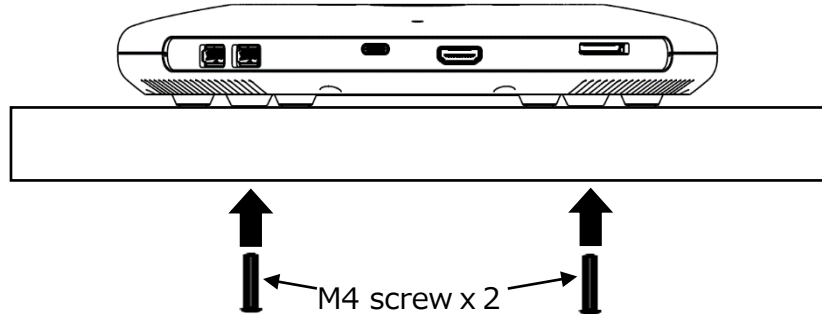

■Dimensions

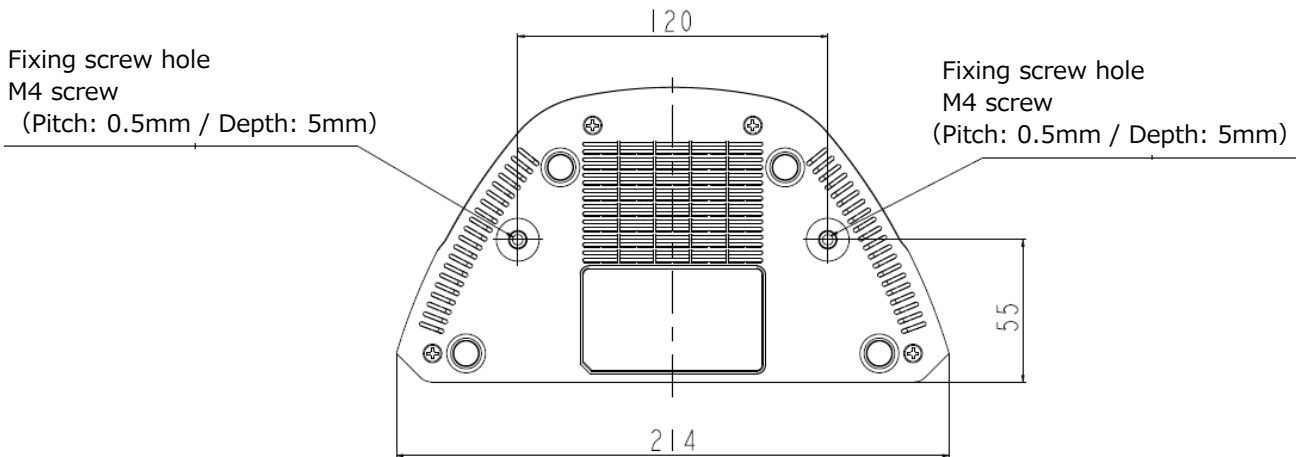

Note

Select a screw that matches the thickness of the desk.
If the screw length is insufficient, the HS-2 cannot be affixed properly.
(For example, if the desk is 20 mm thick, use 25 mm screws.)

◆ABOUT THE FAN

If the built-in fan fails, the unit may become hot or unstable. If the “Fan error” message is displayed, turn off the HS-2 by clicking the “OK” button and stop using the unit. Request a replacement at an additional charge.



3 BASIC OPERATIONS

◆CONNECTING TO A PROJECTOR OR MONITOR

After connecting the HDMI cable to the HDMI Output port of the HS-2, connect it to the HDMI port of the monitor or projector.

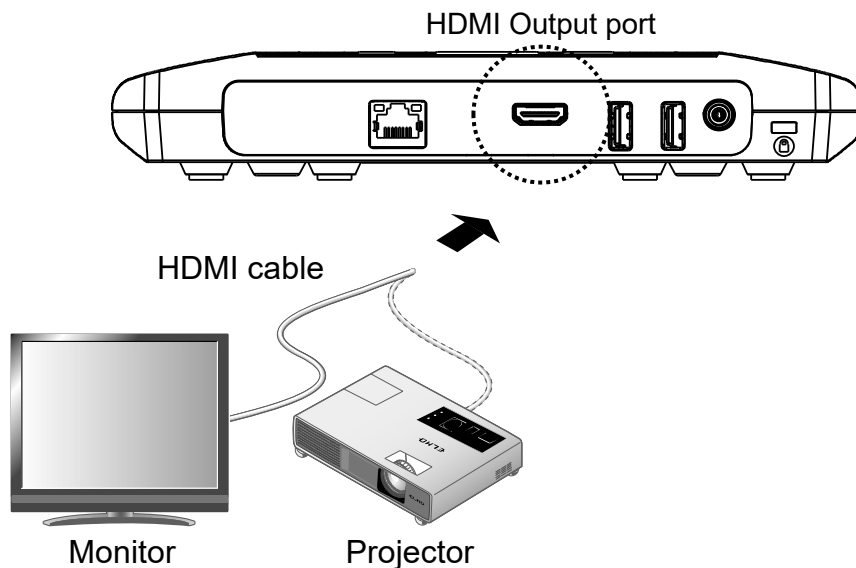

◆CONNECTING TO A POWER SOURCE

Connect the power cable and the AC adapter. Connect the AC adapter to the DC IN 12V port. Then, connect the power cable to a wall outlet.

The power of the HS-2 enters the standby state. (Power LED: flashes red -> lights up red)

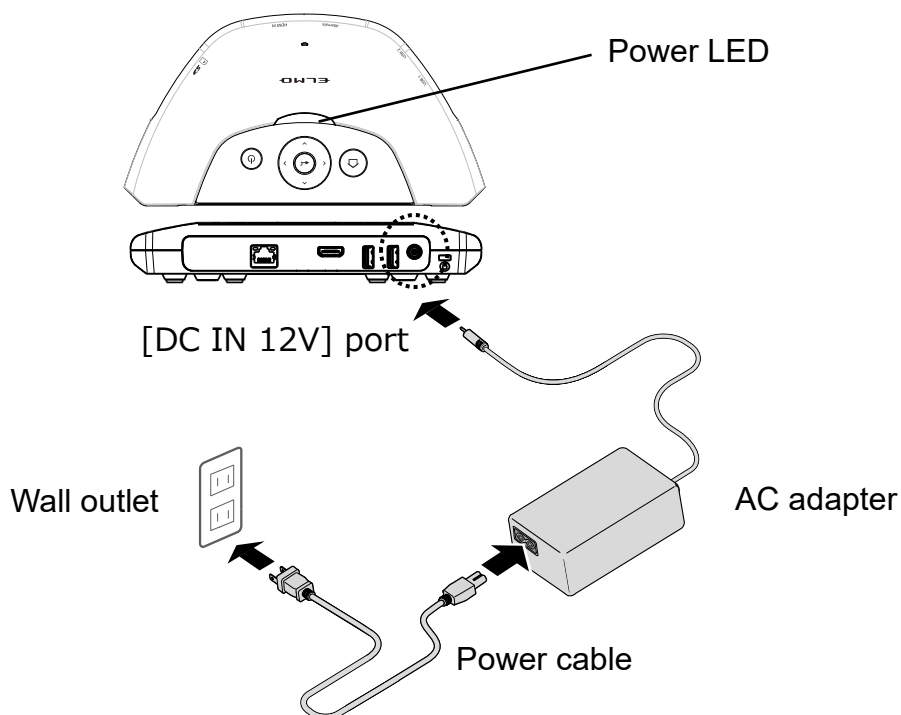

◆POWER ON/OFF

Press the Power button to turn on the power. (Power LED: lights up blue)

Press the Power button again to turn off the power. (Power LED: lights up red)

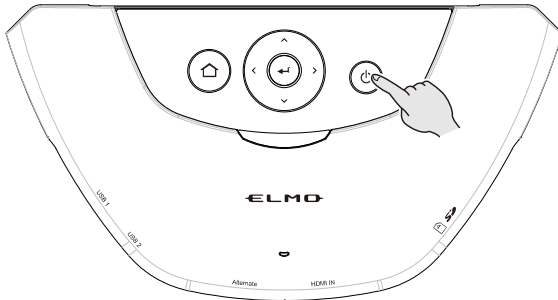

The image signal from the device connected via HDMI or USB Type-C is output from the HDMI Output port. If a device is connected to the HS-2 with a cable and there is no image signal input from the device, the Startup screen appears on the screen.

As shown in the picture, it is possible to do mirroring by connecting to the “connection destination” displayed on the screen via Wi-Fi.

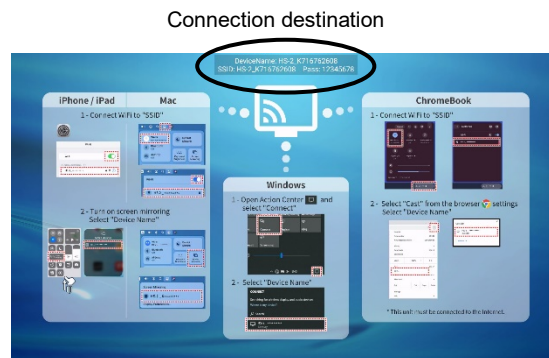

◆SETTING THE DESTINATION

The Destination selection screen is displayed when the HS-2 is started for the first time or after initialization. Select the country you want to use the HS-2 and press the Enter button [] on the remote control to set the destination.

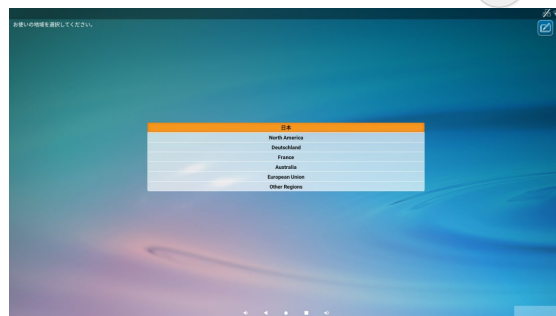

◆INSERTING BATTERIES TO THE REMOTE CONTROL

Remove the cover in the back of the remote control and insert 2pcs of AAA batteries.

- ※Pay attention to the direction of the battery.
- ※Batteries are not included in the product.
- ※Refer to “6 CONFIGURING THE SETTINGS” for details of the pairing of the remote control.

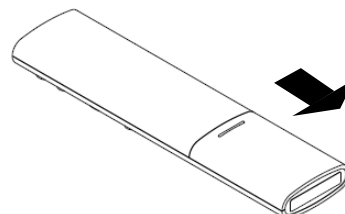

4 USING THE HS-2

■ Hs2Display (Display app)

The HS-2 supports wireless mirroring without installing a dedicated app or using a USB dongle regardless of Windows, iOS, Android, or Chrome OS.

In addition, devices can be connected with cables using the HDMI Input port or USB Type-C port [DisplayPort Alternate].

Up to 4 screens can be switched and displayed at the same time.

※ Up to 4 devices can be connected (wired or wirelessly) at the same time.

If you want to connect more than 5 devices, disconnect one of the connected devices.

Immediately after startup, the Hs2 Display screen is displayed. (Select [] on the Home screen.)

Note

The L-12W, MA-1, and MO-2 support MiraCast.

Devices that have HDMI Output port can be connected to the HDMI Input port.

◆ CONNECTING

■ Connecting with a cable

The image from the device can be displayed by connecting to the HDMI Input port or USB Type-C port [DisplayPort Alternate].

The image being input appears during startup when the device is connected to the HDMI Input port or USB Type-C port.

(Input priority: HDMI Input > USB Type-C [DisplayPort Alternate])

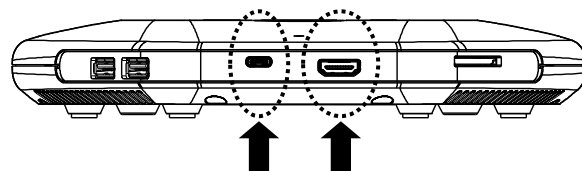

USB Type-C port
[DisplayPort Alternate]

HDMI Input port

■Connecting wirelessly

The image from the device that supports mirroring (such as MiraCast, AirPlay, and Chrome(Google)Cast) can be mirrored.

▶Mirroring via MiraCast

※For details of the mirroring via MiraCast with the document camera, refer to the instruction manual of the document camera.

•When using Android OS

1. Turn on the Wi-Fi setting of your device.
 2. Select [Cast] in the settings menu of your device.
- ※The menu item may be different depending on the device.
 ※If the list does not appear, enable the wireless display setting.
3. Select [HS-2_*****] from the list.

Select [Cast] in the Display settings menu.

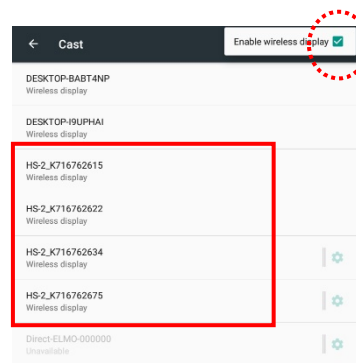
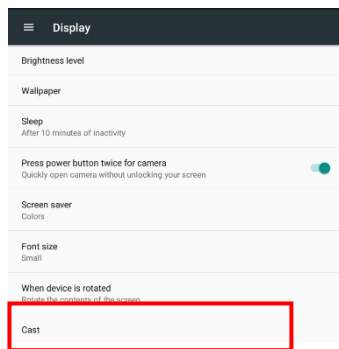



Enable the wireless display.

Select the cast to connect from the list.

- ※Depending on the device the connection procedure may vary.
- ※Android devices do not support the touch back control function.
- ※Some Android devices may not be used with the HS-2.

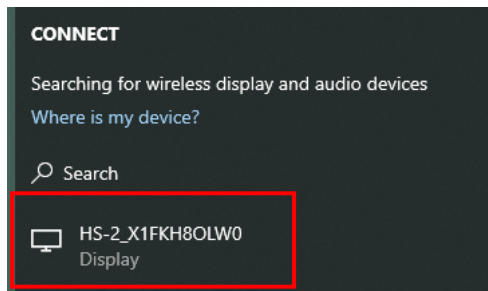

•When using Windows OS (Windows10)

1. Click the Action Center icon [] in the task bar.
2. Click the Connect icon []. ※If this icon is not displayed, click the Open icon.
3. Select [HS-2_*****] from the list.



Select the device to connect from the list.

※ For Windows OS (Windows10) , shortcut keys can also be used.

1. Press the Windows logo key [] on the keyboard of your device and the K key [] at the same time to open the connection list.
2. Select [HS-2_*****] from the list.

► Mirroring via AirPlay

•When using iOS, iPad OS, or Mac OS

1. Turn on the Wi-Fi setting of your device and select the SSID of the HS-2. Then connect the device to the HS-2 via Wi-Fi.
2. From the Control Center of your device, turn on the Screen Mirroring [🖥️].
3. Select [HS-2_*****] from the list.

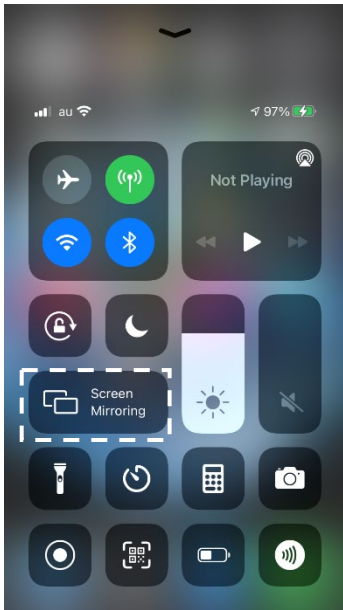

Select "Screen Mirroring".

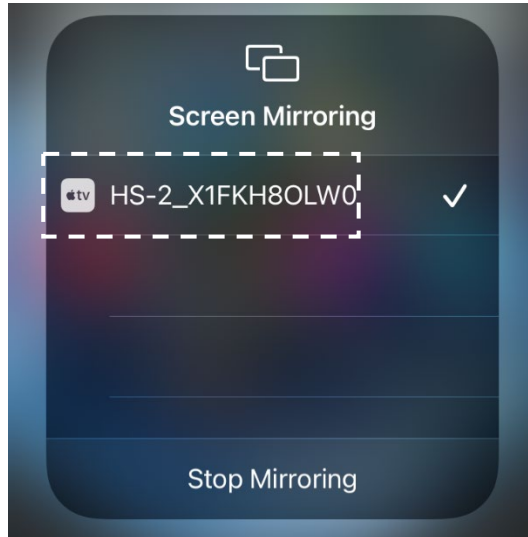

Select the device (HS-2) to connect from the list.

► Mirroring via Chrome(Google)Cast

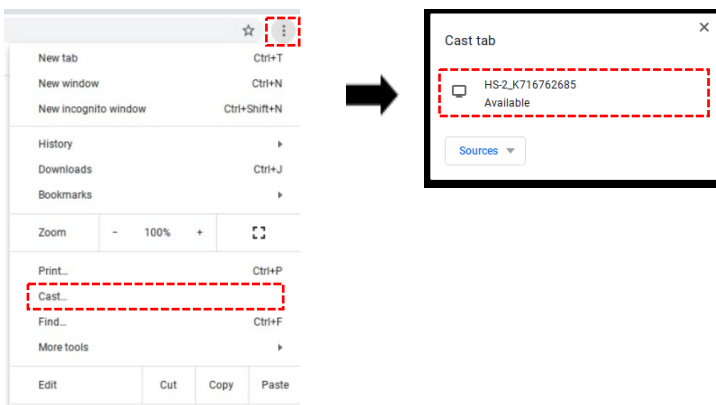

•When using Chrome OS, Windows OS, or Mac OS

1. Connect the HS-2 to the external network (Internet) via LAN or Wi-Fi from the Settings menu [⚙️]. ([Settings] > [System Settings] > [Network and Internet] > [Wi-Fi]).
2. Turn on the Wi-Fi setting of your device and select the SSID of the HS-2.
3. Open the Chrome browser.
4. Tap the icon [⋮] on the top right and tap [Cast].
5. Select [HS-2_*****] from the list.







- ※ No matter which OS is used, you need to connect to the network when casting from the Chrome browser. The password can be entered with the D-pad on the remote control.
- ※ For details of the Wi-Fi connection and mirroring operations, refer to the instruction manual of the respective devices.
- ※ "Cast Desktop" option of Chrome(Google)Cast may not be used on Mac OS. In that case, select "Cast Tab" option or use AirPlay.

◆OPERATING THE HS-2

Press the Cursor button [] on the remote control to display the cursor. Press it again to hide it. You can operate the screen by moving the cursor to the displayed icon and pressing the Enter button [].

※By pressing the D-pad / Enter button on the remote control, the operation icons are displayed.

	Split screen	The screens of the devices connected to the HS-2 are divided and displayed up to a maximum of 4 screens. ※Single screens are displayed in the order in which the devices are connected to the HS-2.
	Single screen	To hide the displayed operation icon. ※The operation icon is automatically hidden.
	Menu display	To display a list of menu items.
	Settings	To change various setting items. ⇒ Refer to “SETTINGS SCREEN”.

■ Switching the screens

Multiple screens can be displayed on the HDMI output screen by connecting the device and the HS-2 with cable or Wi-Fi (mirroring) when Hs2Display screen is displayed.

Multiple screens can be switched between single screen display and split screen display. (Up to 4 screens)

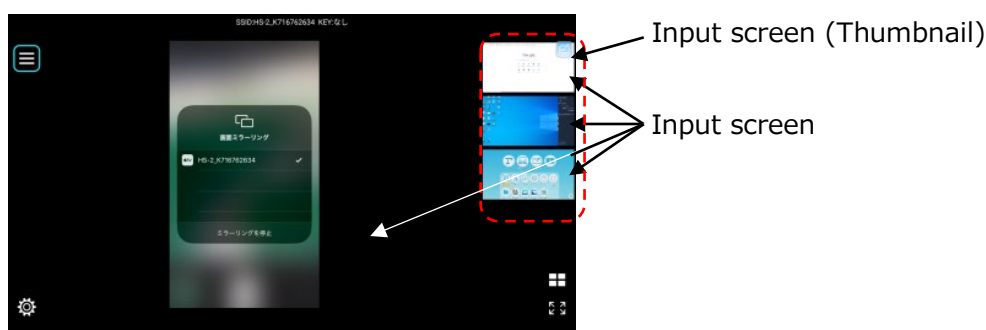

■ Single screen

You can select the screen by clicking the thumbnail twice in a row when displaying a single screen. Switching can also be done by using the Channel button [] on the remote control.



Screen image when multiple devices are connected

■Split screen

The screen can be split up into 4 areas by clicking the Split screen button [] and then clicking [] after making the selection to be displayed.

※A number (split position and selection number) is displayed on the top right of the selected screen.

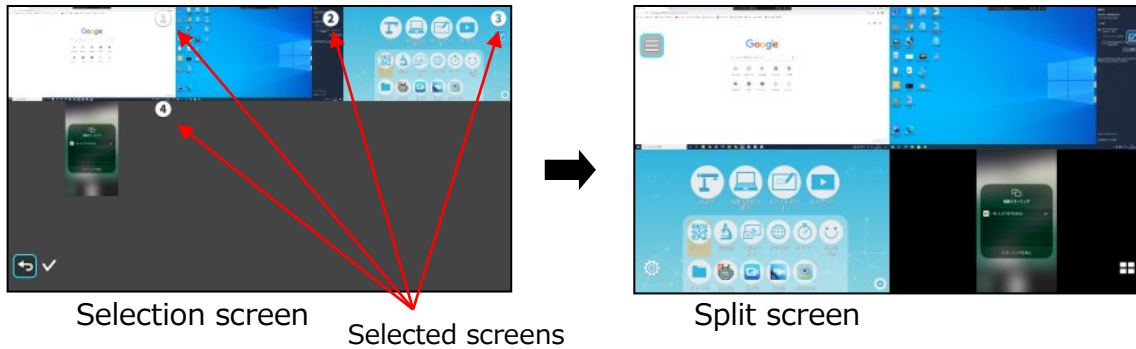

The selected screens are displayed in the following selection order.

①	②
③	④

▶Changing from Split screen display to Single screen display

To enter the Single screen display mode during the Split screen display mode, place the cursor over the screen to be displayed and press the Enter button [].

※The input select status is maintained.

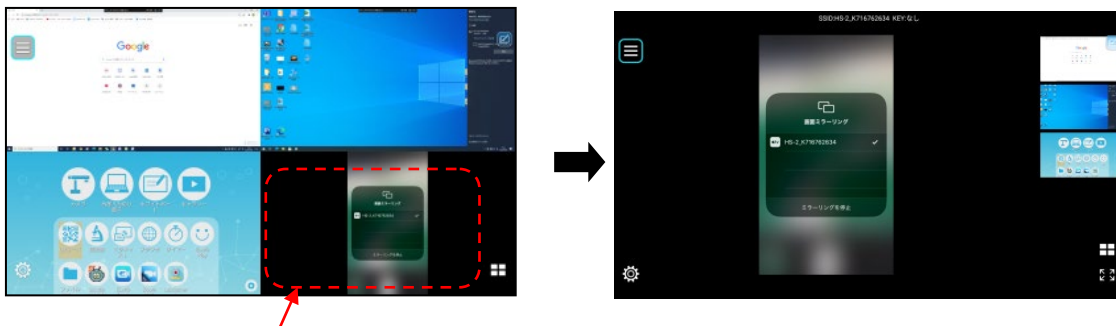

Place the cursor over the screen and press the Enter button





▶Selecting other screen

To return to the Selection screen, click the Split screen button [] during the Split screen display mode.

※The input select status is maintained.







■Menu

The menu is displayed when the Menu display button [] is selected on Hs2Display screen.

	Touch control back	To operate the mouse on your computer using the remote control of the HS-2. ※Check "Allow input" when connecting wirelessly. Compatible only with Windows. Can be used in "Duplicate" mode. If you use in "Extend" mode, misalignment of the cursor and coordinates occurs, preventing stable operation.
	Record	To start / stop recording of the current screen while the Hs2Display screen is displayed. During recording, the record icon is displayed in the upper left of the screen. Select the record icon to stop recording. ※Recording is possible only when using this app. Recording stops if you move to another screen during recording.
	Home	To go to the Home screen.
	Change icon display position	To swap the display position of the menu icon on the left and right of the screen.

■Navigation bar

The Navigation bar [] is displayed when the cursor is moved to the bottom of the screen.

	Volume	To adjust the audio volume. (The volume adjustment bar is displayed on the right side of the screen during operation.)
	Back	To go back to the previous screen. ()
	Home	To go to the Home screen. ()
	List of apps	To display a list of running apps (screens). You can switch apps or close apps.

◆RECORDING

■Still image recording

You can take a still image by pressing the Capture button on the remote control while using the Hs2Home app or Hs2Display app.

The image data can be saved to the SD card, USB flash drive, or internal storage.

The save destination can be changed from the “Save destination” in the settings menu.

※If there is no external memory device connected when the save destination is set to an external memory device, the image data will be saved to the internal storage.

※The save destination can be set in the Recording settings menu. The path differs depending on the save destination.

•When saving to internal storage

HS2¥DCIM¥100_ELMO

•When saving to SD card / USB flash drive

Android¥date¥jp.co.elmo.hs2paint¥files¥DCIM¥100_ELMO

■Video recording

Press the Record button [] on the Hs2Display app to record the current Hs2Display screen. (During recording: The record icon is displayed.)

Press the Record button again to stop recording. The video will be automatically saved to either the SD card or USB flash drive or internal storage. The save destination can be changed from the “Save destination” in the settings menu.

※If there is no external memory device connected when the save destination is set to an external memory device, the image data will be saved to the internal storage.

※Recording can also be stopped by pressing the record icon in the upper left of the screen.

※Recording is possible only when using this app.

※If the HS-2 enters the standby mode during recording, a corrupted file will be generated. Make sure that the HS-2 enters the standby mode after the recording is stopped.

※The save destination can be set in the Recording settings menu. The path differs depending on the save destination.

•When saving to internal storage

HS2¥DCIM¥100_ELMO

•When saving to SD card / USB flash drive

Android¥date¥jp.co.elmo.hs2display¥files¥DCIM¥100_ELMO

◆AUDIO OUTPUT

The following table shows the audio output of the HS-2 for different connected devices and operating conditions.

※The operation sound of the HS-2 is always output.

[HS2Display] (○ : audio is output × : audio is not output)

<When microphone is enabled>

	Input		Output		
	Video input	USB (audio)	HDMI Out	External speaker	Recording
Single screen	HDMI or USB Type-C is connected	Not connected	× ※1	-	Built-in mic.
		External mic.	× ※1	-	External mic.
		External speaker	-	× ※1	Built-in mic.
		USB mic.&speaker	-	× ※1	External mic.
	Mirroring connection is established	Not connected	○ ※2	-	Built-in mic.
		External mic.	○ ※2	-	External mic.
		External speaker	-	○ ※2	Built-in mic.
		USB mic.&speaker	-	○ ※2	External mic.
Split screen (4 screens)	Video input	USB (audio)	HDMI Out	External speaker	Recording
	HDMI & USB Type-C are connected & Mirroring connection is established	Not connected	○ ※3	-	Built-in mic.
		External mic.	○ ※3	-	External mic.
		External speaker	-	○ ※3	Built-in mic.
		USB mic.&speaker	-	○ ※3	External mic.

<When microphone is disabled>

	Input		Output		
	Video input	USB (audio)	HDMI Out	External speaker	Recording
Single screen	HDMI or USB Type-C is connected	Not connected	○ ※4	-	○ ※5
		External mic.	○ ※4	-	
		External speaker	-	○ ※4	
		USB mic.&speaker	-	○ ※4	
	Mirroring connection is established	Not connected	○ ※2	-	×
		External mic.	○ ※2	-	×
		External speaker	-	○ ※2	×
		USB mic.&speaker	-	○ ※2	×
Split screen (4 screens)	Video input	USB (audio)	HDMI Out	External speaker	Recording
	HDMI & USB Type-C are connected & Mirroring connection is established	Not connected	○ ※6	-	○ ※7
		External mic.	○ ※6	-	
		External speaker	-	○ ※6	
		USB mic.&speaker	-	○ ※6	

- ※1 The audio of the connected source (HDMI or USB Type-C) is not output.
- ※2 The audio of the mirrored device (AirPlay, MiraCast, Chrome(Google)Cast) is output.
- ※3 The audio of the mirrored device (AirPlay, MiraCast, Chrome(Google)Cast) is combined and output. The audio of the HDMI or USB Type-C is not output.
- ※4 The audio of the HDMI or USB Type-C is output.
- ※5 The audio of the HDMI or USB Type-C is recorded.
- ※6 The audio of the mirrored device (AirPlay, MiraCast, Chrome(Google)Cast) is combined and output. The audio of the HDMI or USB Type-C, whichever connected later, is output.
- ※7 The audio of the HDMI or USB Type-C is recorded. The audio of the mirrored device is not output.

[Browser, file (playback)] (The audio is output regardless of the microphone settings.)

USB (audio)	Microphone	Speaker
Not connected	Built-in mic.	HDMI Out
External speaker	Built-in mic.	External speaker
External mic.	External mic.	HDMI Out
USB mic.&speaker	External mic.	External speaker

Note) For the USB connection, the one connected later has priority.

Example) If you connect a speaker later while a USB mic.&speaker is connected, the USB mic.&speaker cannot be used, and only the speaker connected later can be used.





5 ADVANCED OPERATIONS

HOME SCREEN

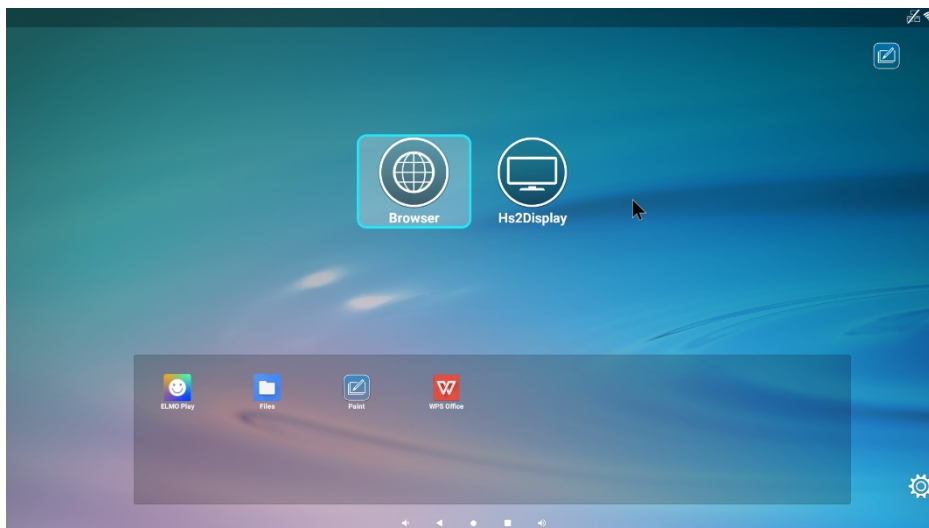

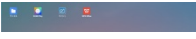

Press the Home button [] on the remote control to move to the Home screen.

Move the cursor on the remote control to the application (icon) you want to use and press the Enter button [] to start the application.



	Browser	To display a web browser by connecting to an external network after inserting a LAN cable into the LAN port on the back. → You can search the browser and watch videos.
	Hs2Display	This app is displayed at startup. The images from devices connected to the HS-2, wirelessly or wired, can be switched and displayed as desired. Max 4 split screen display is possible.
	Paint	To draw on various screens with a pen or marker.
	List of apps	To display the installed apps and launch the selected app.
	Settings	To change various setting items. ⇒ Refer to "SETTINGS SCREEN".
	Status	To check the network status.

◆LIST OF APPS

	File	To open the storage such as internal storage, SD card, and USB flash drive. File operation is possible.
	Paint	To draw on various background images using a pen or marker.
	Video conference app (EZT)	To do a video conference via the Internet. ※ EZT will be released on ELMO Play.
	WPS Office	To open Office documents and PDF files.
	ELMO PLAY	To update or install apps via the network.

PAINT









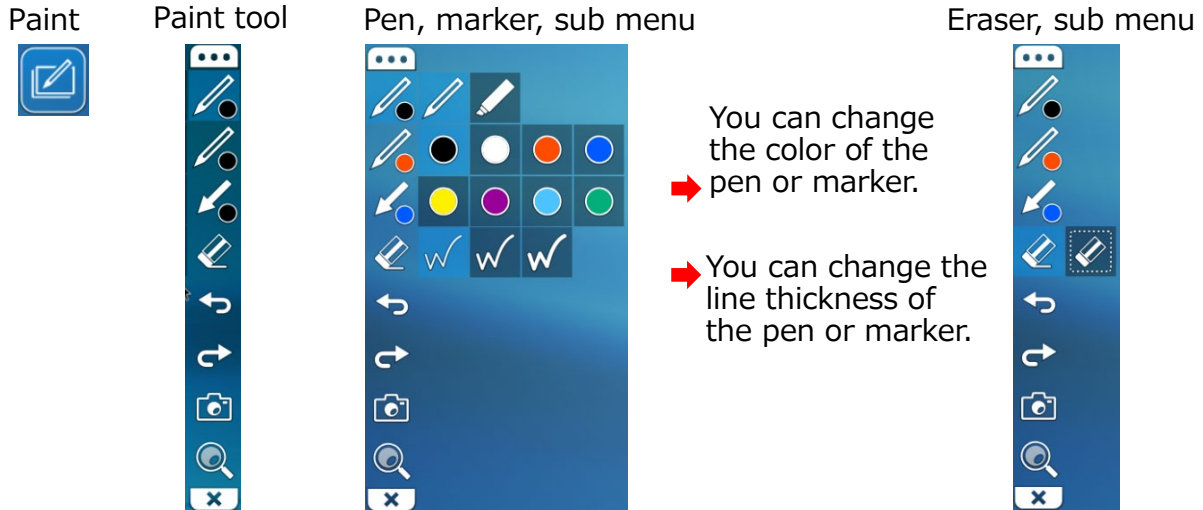



By selecting the [] icon on the screen, you can display the Paint tool with icons such as pen, marker, and eraser to draw on the screen.

Select a pen, marker, or eraser to display a sub menu where you can change the type of pen or eraser.



※The selected icon will be highlighted (background: light blue).

※If you perform the capture or record function while writing on the screen, the written/drawing content will be recorded.





Paint tool		
Item	Icon	Function
Move tool		To move the Paint tool around the screen using drag and drop.
Pen 1 Pen 2		To draw a line.
		To draw a transparent marker line.
Marker		To draw a marker line. The icon disappears after drawing.
		To draw a transparent marker line. The icon disappears after drawing.
Eraser		To delete the drawing by tapping it.
		To delete all the drawings by tapping this icon.
Undo / Redo		To cancel the last drawing action and returns to the previous operation.
		To redisplay the drawing canceled by "Undo" and the line partially erased by the eraser.
Capture		To capture the screenshot. (Still image capture)
Enlarge / Shrink		To enlarge the screen.
		To shrink the screen.
Exit		To close the Paint tool and return to the Paint icon. When using Zoom, the Paint tool is displayed.

◆ DRAWING ON THE SCREEN



Step1. Press the Cursor button [] on the remote control to display the cursor [].

Step2. Select the Paint icon [] to display the Paint tool.

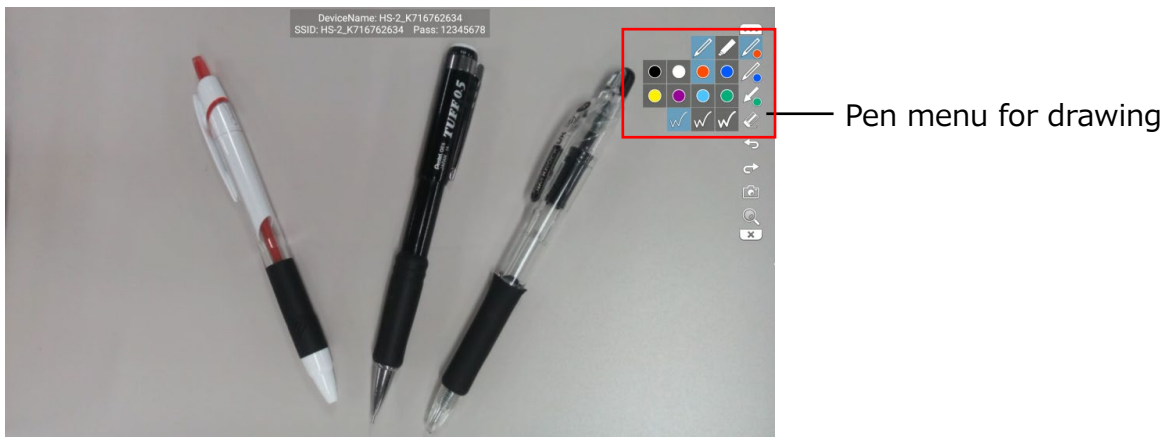

Step3. Select the Pen icon [] to display a sub menu. You can select pen type, thickness, and color. Select the Pen icon again to close a sub menu. (The cursor [] changes to the pen [].)



Step4. Start drawing by moving the pen [] while pressing the Enter button [] on the remote control.

Note:

- When playing videos such as YouTube with the Browser app, or when playing videos in the internal storage with the Gallery app, drawing is not possible with the Paint app.
- Make sure to play still images or videos with the File app. Otherwise, you may not be able to draw normally.

■ BROWSER

When the Browser icon [] on the Home screen is selected, a browser starts up and you can access the Internet.

※Complete the network settings of the HS-2 in advance.

(Refer to “⑥ CONFIGURING THE SETTINGS ◆ CONNECTING TO THE NETWORK”.)

※Videos such as YouTube can be played, but some videos cannot be played. Electronic textbooks can be displayed, but some functions may be restricted.

※If you want to use the browser by connecting to a network with proxy settings, you need to set the proxy settings from the browser settings.

Set the proxy from "General settings" in the settings menu of the browser.

■ FILE

By selecting the File icon [] on the Home screen, you can open the storage such as internal storage, SD card, and USB flash drive.

◆ SELECTING THE FILE

Move the cursor with the remote control to the storage you want to open and press the Enter button [].

A list of files and folders in the selected storage is displayed. Move the cursor to the file you want to open and press the Enter button [].

■ Playing the file



When the Enter button [] is pressed twice when selecting a file, the selected file is played (if it can be played).

If a folder is selected, the contents in the folder are listed.

※Content cannot be switched with the D-pad during playback.

※Videos up to 4K / 30fps can be played. Some videos such as 4K / 60fps videos may not be played normally.

■ Operating the file

When you move the mouse cursor to the File icon and select it with the Enter button [], a check mark [] is displayed, indicating that the file has been selected.

While the file is selected, the File operation menu is displayed at the top of the screen, and you can perform operations such as deleting [] and others (copy, move, etc.).

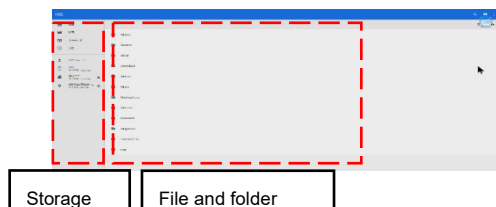

※File sharing operation [] is not possible.

※When you open a file using a USB mouse, left-click the mouse to open. It cannot be opened normally by right-clicking the mouse and selecting "Open File".

■ VIDEO CONFERENCE APP (EZT)

With this app, you can do video conference using the HS-2.

※EZT needs to be downloaded and installed from ELMO Play. (To be updated at a later date.)

■ ELMO Play

ELMO Play is an application for installing apps from the ELMO portal site.

With ELMO Play, you can install convenient apps or update apps. (Some apps are chargeable.)

◆ INSTALLING AN APP

Connect to the Internet and select the ELMO Play app.

Select the app you want to install and start the installation.

※When installing, you are asked if you want to install unknown app.

The apps on the ELMO portal site are provided by the application developer.

Select "Allow installation" to install.

◆ UNINSTALLING AN APP

If you press and hold the icon of the app to be uninstalled, the trash can icon appears at the bottom left of the screen.

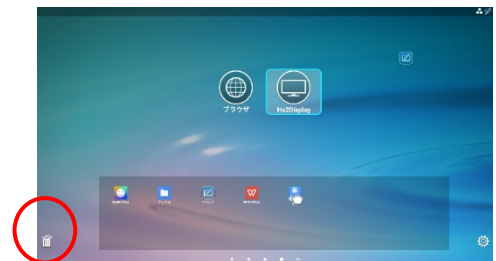













You can uninstall the app by dragging and dropping the app icon onto the trash can icon.

※ Pre-installed apps cannot be uninstalled.





6 CONFIGURING THE SETTINGS





◆ SETTINGS SCREEN

Select [] on the Hs2Display screen (display app) or Home screen to display the Settings screen.
Tap [] to return to the Hs2Display screen (display app) or Home screen.

Network settings						
Icon	Name	Selection item	Setting value		Function	
	System settings	System settings	-		To configure the Android settings.	
	Network settings	AP on at startup	Enabled / Disabled		To enable or disable Startup AP (Access Point). Default setting: Enabled	
		Wi-Fi	Enabled / Disabled		To enable or disable Wi-Fi. When set to "Enabled" a Wi-Fi list is displayed. Select the Wi-Fi to use and set it. Default setting: Enabled	
		Ethernet		IP address netmask gateway dns1 dns2		To display various information when connected to Ethernet with LAN cable. static: To display information about network setting such as IP address configured manually. dhcp: To display information about network setting such as IP address acquired automatically.
				Ethernet Ip mode	static / dhcp	
			Wireless connection to external AP	Enabled / Disabled		To enable or disable the setting to connect to an external AP. When set to "Enabled", you can connect to an external AP. Default setting: Disabled *If you change the setting, the HS-2 will restart.
		Proxy settings	Proxy status	Enabled / Disabled		When set to "Enabled", "Proxy host" and "Proxy port" are enabled, and the HS-2 can connect to the Internet via a proxy server. Default setting: Disabled
			Proxy host	-		To enter IP address of proxy server. Specify the IP address excluding "http: //".
			Proxy port	-		To enter port number of proxy server.
		WLAN channel	AP (Access Point)	(2.4GHz) 1ch/2ch/3ch/4ch 5ch/6ch/7ch/8ch 9ch/10ch/11ch		To make settings for WLAN channel for "AP (Access Point)" and "MiraCast". Default setting: AP (Access Point) 48ch MiraCast 36ch ※The HS-2 automatically restarts when the setting is changed.
			MiraCast	(5GHz) 36ch/40ch/44ch/48ch/Auto		
		Wi-Fi (STA)	-		To display SSID and channel for the connected Wi-Fi.	

Hs2DisPlay settings				
Icon	Name	Selection item	Setting value	Function
	OSD setting	Display or hide connected devices	Display / Hide	To display or hide connection destination on the Hs2DisPlay app. Default setting: Display
		Display position	Top right / Top left / Bottom right / Bottom left / Top / Bottom	To make settings for display position when the Connection destination display setting is set to "Display". Default setting: Top
	PIN settings	PIN	Enabled / Disabled	To enable or disable PIN when connecting to AirPlay. Default setting: Disabled
		PIN code	-	To enter PIN code. Default setting: 0000
	Cast settings	AirPlay	Enabled / Disabled	To enable or disable AirPlay. Default setting: Enabled
		MiraCast	Enabled / Disabled	To enable or disable MiraCast. Default setting: Enabled
		GoogleCast	Enabled / Disabled	To enable or disable Chrome(Google)Cast. Default setting: Enabled
		Automatic switching	Enabled / Disabled	To automatically switch the screen when a new connection is detected. Default setting: Enabled
		4K input	Enabled / Disabled	To enable or disable 4K input on HDMI or USB Type-C. Default setting: Disabled ※AirPlay, MiraCast, Chrome(Google)Cast cannot be used if this setting is enabled. ※The HS-2 automatically restarts when the setting is changed.
	Recording settings	Mute	Enabled / Disabled	To enable or disable the mute function during recording. Default setting: Disabled
		Microphone	Enabled / Disabled	When the microphone is enabled, the audio source is set to the microphone. Disabling the microphone will switch the audio source to HDMI or USB Type-C. Default setting: Disabled
		Recording quality	High Normal Low	To make settings for recording quality. Default setting: Normal
		Save destination	SD card USB flash drive Internal storage	To make settings for the save destination of recorded image or video. Default setting: SD card ※If no external memory is connected, the recorded image or video will be saved in the internal storage.

Product information		
Icon	Name	Function
	Android Version	To display the version of Android OS.
	Build number	To display the build number of Android OS.
	Serial number	To display the serial number of the unit.
	Wi-Fi MAC Address 1	To display Wi-Fi MAC Address of the unit for the mirroring via MiraCast.

	Wi-Fi MAC Address 2	To display Wi-Fi MAC Address of the unit for AP.
	Bluetooth MAC Address	To display Bluetooth MAC Address of the unit.
	Ethernet MAC Address	To display Ethernet MAC Address of the unit.
	Initialization	To reset the Destination settings and other settings to factory default. ※The HS2 will restart and the Destination selection screen will be displayed.

※After entering the text such as the proxy host name, press the Enter button and confirm that the text you entered is displayed on the left side.

※About WLAN channel

If you want to select a channel for MiraCast that is grayed out, change the channel for AP from “WLAN channel” in the Network settings screen.

If you want to select a channel for AP that is grayed out, change the channel for MiraCast from “WLAN channel” in the Network settings screen.

※About MiraCast channel









Only W52 of 2.4GHz and 5.0GHz can be set.

If you enable the "Wireless connection to external AP" setting, the WLAN channel setting for MiraCast will be automatically set to Auto.

If the MiraCast channel and the external AP channel are different, set them to be the same.

※When you change the channel of the external AP, restart the HS-2.

To display the settings screen, click “System settings” [].

System settings		
Icon	Name	Function
	Hotspot is on	To indicate that the access point is on. (The access point can be turned off by pressing this icon.)
	Network & internet	To make settings for network and Internet such as Wi-Fi function and Ethernet.
	Connected devices	To display connected devices or make settings for pairing for remote control.
	Apps and notifications	To display recently used apps or make settings for notification and advanced functions.
	Display	To make settings for the screen display, such as HDMI output resolution and display size.
	Storage	To make settings for storage or check the used capacity of the memory.
	Accessibility	To make settings for accessibility options such as font size and display size.
	System	To make settings such as language, keyboard, and time settings, or reset the system.
	About tablet	To display information about your tablet. You can change the name of the device.

※Do not change the following items in the System settings. Otherwise the HS-2 may not work properly.

- Do not change the Home app from Hs2Home.
- Do not change the Sleep setting from OFF.
- Do not use the screen saver.
- Do not use “Reset app preference” of the Reset options.
- Do not use “Install” of Network certificate setting.
- Do not use VPN settings.

◆CONNECTING TO THE NETWORK

■LAN settings

Connect the HS-2 to the network using a LAN cable.

Press the Settings button [] to open the Settings screen.

Then configure the settings from the Ethernet menu [].

※If a LAN cable is connected and the "Ethernet" setting is completed, the LAN connection has priority over Wi-Fi. (⇒P.31 : Ethernet)

When DHCP is set to "ON", the HS-2 automatically connects to the network. To enter the IP address manually, set it to "OFF".





※The setting items of the Ethernet menu will not be reset by the Initialization menu. Change the setting items of Ethernet from this Ethernet settings menu.

■ Wi-Fi settings

Step1. Select the Home button to display the Home screen.

Step2. Press the Settings button [] to open the Settings screen.

Then go to [System settings][] > [Network and internet][] > [Wi-Fi][].
(⇒P.31 : Wi-Fi)

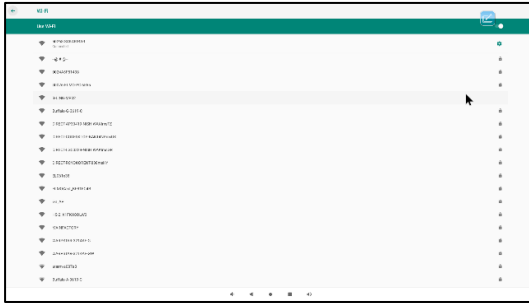

Step3. A list of SSID is displayed. Select the SSID to connect.

Step4. If the security setting is enabled, the Password entry screen is displayed. Tap the password field and enter the password on the keyboard.

※To connect to stealth Wi-Fi, you need to set "Hidden network" setting in "Advanced options" to "Yes".

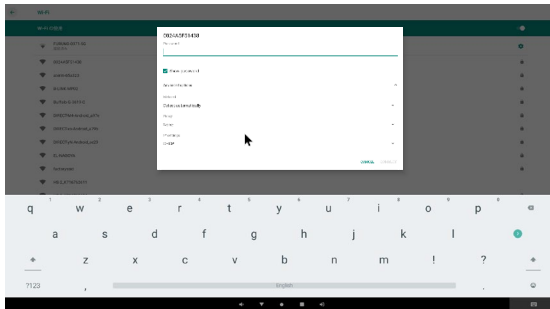

Step5. Tap or click the "Connect" button to connect to the Wi-Fi network.

Note

With the HS-2, it is possible to change the channel of MiraCast and AP as a countermeasure against wireless interference.





The HS-2 supports only W52 of 5GHz and does not support W53 (52-64ch) and W56 (100-140ch).

When connecting to an external wireless access point, make sure to set the MiraCast channel to the same channel as the external wireless access point. Otherwise mirroring via MiraCast may not work normally.

◆ NETWORK PROXY SETTINGS

Proxy settings for the HS-2 can be configured. The setting procedure varies depending on the connection method.

■ Ethernet





1. Press the Settings button [] to open the Settings screen.
2. Enable the Proxy status setting [] of "Proxy settings" in "Network settings".
3. You will be able to set Proxy host [] and Proxy port [] now.
4. Enter the proxy server address in the "Proxy host" field and the proxy server port number in the "Proxy port" field.

※If you set the proxy for Ethernet, the proxy settings will also be reflected in Wi-Fi.

※If you set the proxy for both Ethernet and Wi-Fi, the proxy settings for Ethernet has priority. If you want to use the proxy settings for Wi-Fi while the proxy are set for both Ethernet and Wi-Fi, disable the proxy settings for Ethernet.

■ Wi-Fi

The proxy can be set when connecting to the SSID from "Wi-Fi" in the System settings.

1. Select the Home button to display the Home screen.
2. Press the Settings button [] to open the Settings screen.
Go to [System settings][] > [Network and Internet][] > [Wi-Fi][].

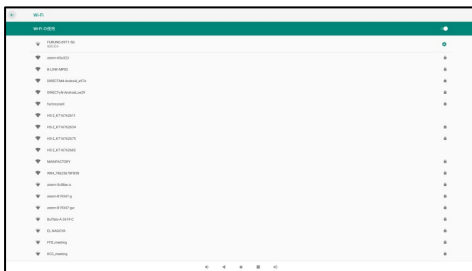

3. A list of SSID is displayed. Select the SSID to connect.



4. Enter the password. Open "Advanced options" and set the proxy settings.



※If the proxy is set only for Wi-Fi, it will not be reflected in Ethernet.

■ Browser





To use the proxy in the browser you need to set the proxy settings from the settings menu of the browser.

Set the proxy from "General settings" in the settings menu of the browser.

※Set the proxy setting for the browser separately. The proxy settings set for Ethernet and Wi-Fi will not be reflected in the browser.

◆PAIRING OF THE REMOTE CONTROL

The remote control is paired at the factory. In the unlikely event that the remote control becomes unusable or is replaced with a new one due to a malfunction, perform the following pairing procedure:

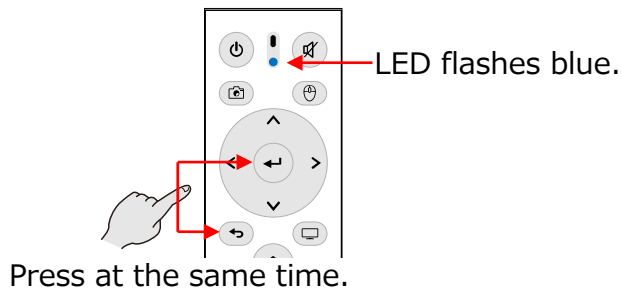

1. Press the Settings button [] to open the Settings screen.
2. Go to [Settings] > [System settings][] > [Connected devices][].
3. Press the Return button [] and the Enter button [] on the remote control at the same time.

The LED on the remote control flashes blue.

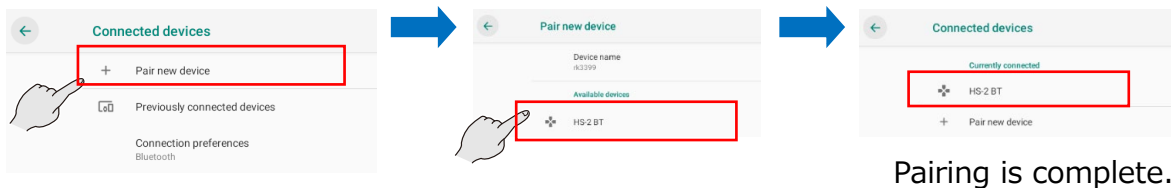

4. Go to [Pair with a new device] > [HS-2 BT].
The blue LED stops flashing and pairing is complete.





5. Press the Cursor button [] on the remote control to display the cursor []. Shake the remote control. Pairing is successfully complete if the cursor moves according to the movement of the remote control.

Note

If pairing is not successful, delete the registered device before pairing.

◆ RESOLUTION OF THE MONITOR

1. Press the Settings button [] to open the Settings screen.
2. Go to [Settings] > [System settings] [] > [Display] [].
3. Go to [Advanced settings] > [HDMI] > [Resolution].

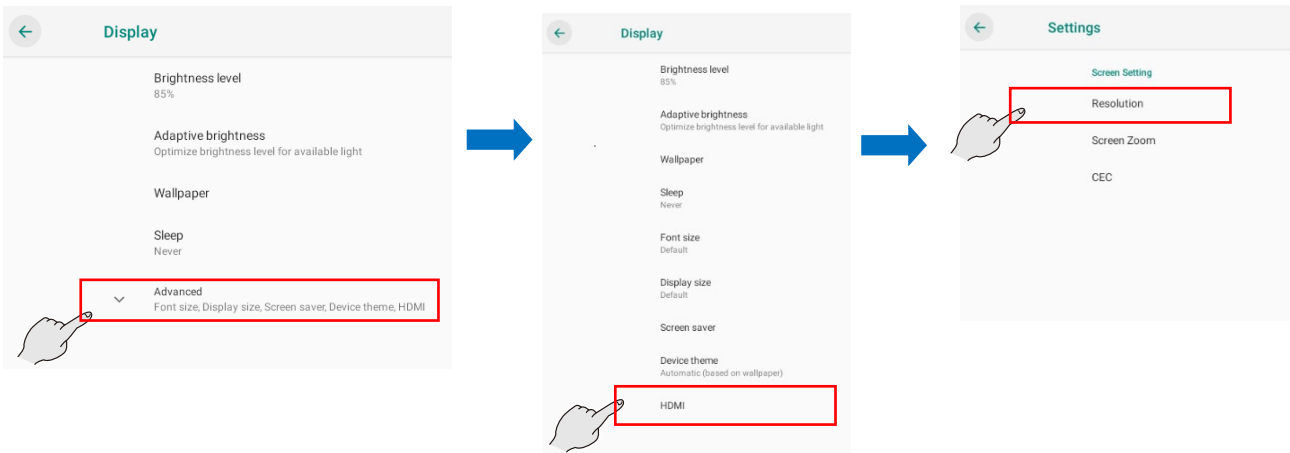

4. A list of resolutions available on your display appears.
Select the resolution you want to use.
※Default setting: AUTO

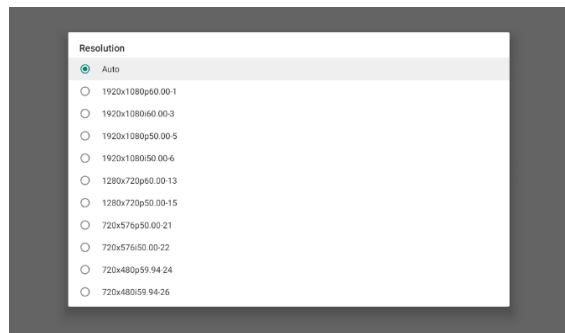

◆ DATE AND TIME SETTINGS

1. Go to [System settings] [] > [System] [] > [Date and Time] [].

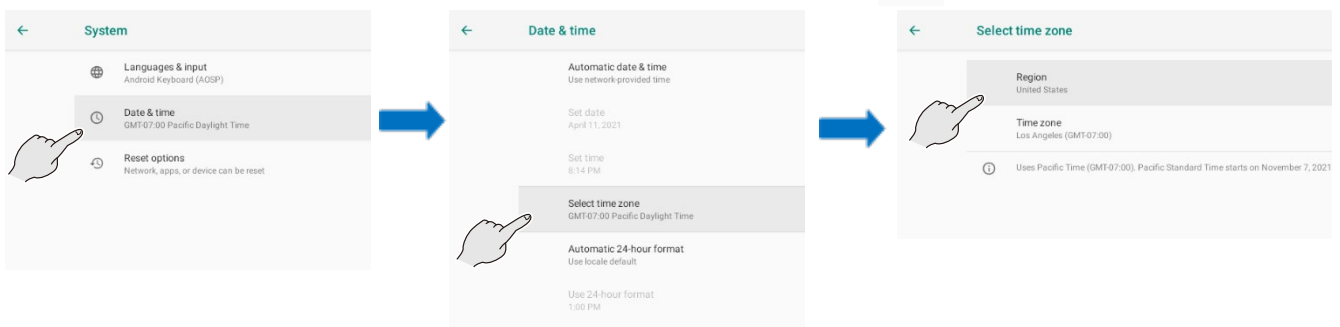

2. Set the time zone you want to use in [Select Time Zone].

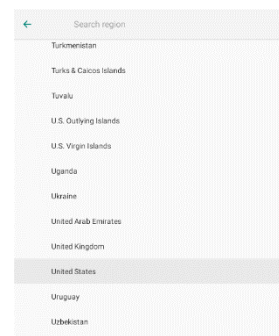

◆ KEYBOARD SELECTION

There are two keyboards available, a Japanese keyboard and an English keyboard. The Japanese keyboard only supports romaji typing.

1. Select the text input screen to display the keyboard.

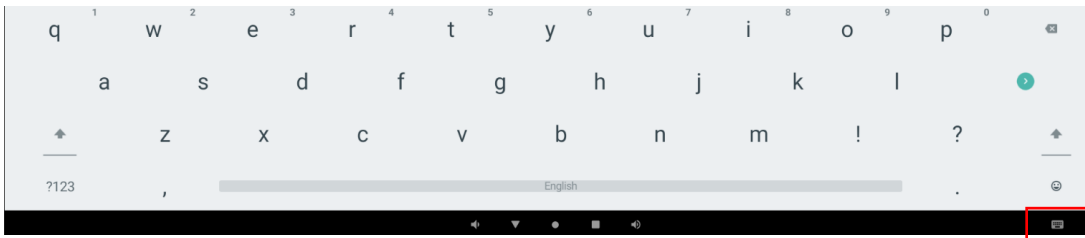

2. You can select a Japanese keyboard or an English keyboard with the Keyboard icon [] that appears at the bottom right of the screen.

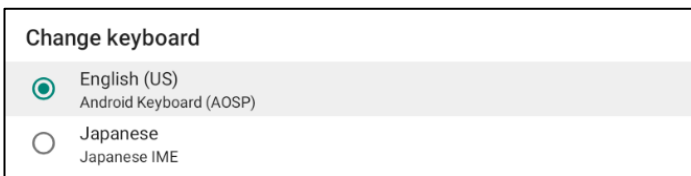

English keyboard

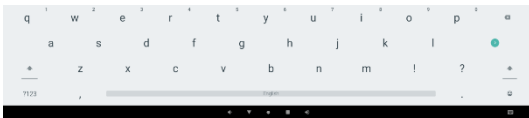



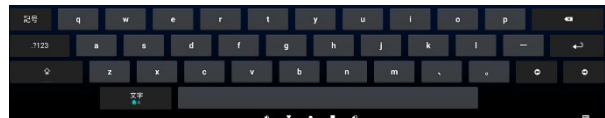

Japanese keyboard

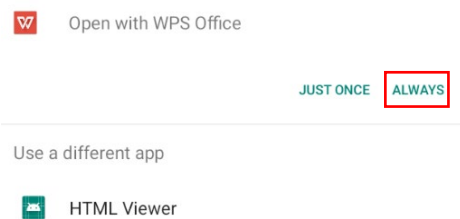

◆ APP SELECTION

In some cases the following App selection dialog may appear.



If the above dialog is displayed, select Lightning [], WPS Office [], Hs2Home [], Gallery / Video Player []. If you select another app, the selected app or the HS-2 may not work normally. Select "Always".

7 FAQ (Frequently asked questions and answers)

■ Cast

▶ General

Q. It is not possible to do the mirroring. The mirroring session is often terminated.

A. • Try to reconnect or restart the HS-2 and the input device.

→The problem may be improved by reconnecting or restarting the HS-2 and the input device.

• **Wi-Fi is off.**

→Go to [Network & Internet] in the Settings menu and turn on Wi-Fi.

• **The firewall of the input device is enabled.**

→If the firewall is enabled, it may not be possible to connect the HS-2 and the input device.

• **MiraCast channel and AP channel may be interfering with each other.**

→Change the MiraCast channel from the WLAN channel settings menu. The problem may be solved by changing the channel.

• **The Cast settings of the HS-2 are disabled.**

→If the Cast settings are disabled, it is not possible to connect the HS-2 and the input device.

Also, if "Automatic switching" setting in the Cast settings is disabled, the video of the second and subsequent devices will not be displayed automatically. In that case, manually switch the screen and select the video of the device to be displayed.

• **The input device is in standby mode.**

→The mirroring session may be terminated when the input device is in standby mode.

• **Wi-Fi is cut off or signal is weak.**

→Check the radio wave environment.

• **Sometimes it fails to establish a mirroring connection. / Sometimes a mirroring session is terminated.**

→When using the HS-2 by connecting it to an external AP wirelessly (Wi-Fi), you may fail to establish a mirroring connection or a mirroring session may be terminated depending on your environment. The problem may be improved by connecting the HS-2 to an external AP via a wired LAN.

Q. Are there any ports that need to be opened to use each cast?

A. Port configuration may be required to do the mirroring. Contact the dealer from whom you purchased the product for further information.

Q. The mirrored video freezes or turns black.

A. The app may be unstable. The problem may be improved by restarting the HS-2 or the Hs2Display app.

▶ MiraCast

Q. It is not possible to do the mirroring via MiraCast.

A. • The network card driver or graphic card driver of your computer is not the latest version.

→If the network card driver or graphic card driver is not the latest version, update it to the latest version with the driver wizard. The problem may be solved.

• **You are using a computer with Windows 10 updated from Windows 7 or Windows 8.**

→It is not possible to do the mirroring via MiraCast using a computer with Windows 10 updated from Windows 7 or Windows 8. Do the mirroring via Chrome(Google)Cast instead.

• **The Mobile Hotspot setting of your computer is on.**

→If the Mobile Hotspot setting of the computer is on, the HS-2 may fail to establish a MiraCast connection with the computer. Turn off the Mobile Hotspot setting of the computer.

• **The Group Policy is blocking MiraCast.**

→ On domain-joined devices, Group Policy may block MiraCast.

• **Your smartphone does not support MiraCast.**

→ Some smartphones do not support MiraCast. Check the instruction manual of your device. If mirroring via MiraCast is not possible, try to use Chrome(Google)Cast.

Q. It is not possible to use the Touch back control function in “Extend” mode during the mirroring.

A. The Touch back control function can only be used in “Duplicate” mode. If you use in “Extend” mode, misalignment of the cursor and coordinates occurs, preventing stable operation. Use the Touch back control function in “Duplicate” mode.

▶ **AirPlay**

Q. It is not possible to do the mirroring via AirPlay.

A. When mirroring via an AP, the input device needs to be connected wirelessly to the HS-2 or an AP that exists on the same network as the HS-2.

→ Connect the input device to the HS-2 or an AP that exists on the same network as the HS-2.

• **The device is connected to Virtual Private Network (VPN) or a proxy server.**

→ Depending on your network environment, the HS-2 may not be able to communicate with the input device. Try to disable VPN and proxy settings.

▶ **Chrome(Google)Cast**

Q. It is not possible to do the mirroring via Chrome(Google)Cast.

A. The HS-2 is not connected to the Internet.

→ Internet access is required to use Chrome(Google)Cast. The input device and the HS-2 must be on the same network.

• **The device displaying the Chrome browser is not on the same network as the HS-2.**

→ If the device and the HS-2 are not on the same network, connection may not be established. If you want to connect them beyond the network, we recommend that you check in advance under your usage environment.

• **Your Chrome browser is not the latest version.**

→ The problem may be improved by updating the browser to the latest version.

• **The device is connected to Virtual Private Network (VPN) or a proxy server.**

→ Depending on your network environment, the HS-2 may not be able to communicate with the input device. Try to disable VPN and proxy settings.

• **The time of the input device, the time of the HS-2, and the time of the Internet are not synchronized.**

→ If you set the clock manually, you may not be able to connect the HS-2 and the input device.

The problem may be improved by enabling the Automatic time synchronization setting to always set the clock correctly.

• **If the Chrome settings of your Mac do not allow external connections, you will not be able to use Chrome(Google)Cast on your Mac.**

Follow the steps below to see if external connections are allowed in the Chrome settings.

1. Click the Apple icon at the top left of the screen.

2. Go to [System Environment setting] > [Security and Privacy] > [Firewall].

3. If the firewall is enabled, go to [Firewall Options]. (If the firewall is disabled, skip the next steps).

4. If [Block all external connections] setting is enabled, disable this setting. After saving the setting, close Chrome and reopen it. Then try again.

5. If [Automatically allow signed software to receive incoming connections] is enabled, do not include the Google Chrome entry in the list of applications.
 6. If [Automatically allow signed software to receive incoming connections] is disabled, click [+] button and select Chrome in the application folder.
- **You are logged in to your Chrome browser or ChromeBook as a Guest.**
→ You need to log in with an account other than Guest.

■ Audio and Video

Q. The image quality is poor. (The image freezes or delays or there is block noise in the image.)

A. • The radio wave environment may be bad.

→ When using the HS-2 in the 2.4GHz band, radio wave interference may occur with microwave ovens, Bluetooth products, wireless routers, etc. Use the HS-2 in the 5GHz band or keep it away from interference sources. Do not block the HS-2 or the input device with metal cabinets, walls, TVs, etc. Obstacles (especially metal) can reduce the quality of communication.

• **Data with a large amount of text information such as an Excel file and a novel is displayed via MiraCast.**

→ Due to the nature of the mirroring, block noise may be noticeable when displaying static data. The block noise may be reduced by displaying a moving object or by changing the radio wave environment or by reconnecting the HS-2 and the input device.

Q. Video content such as YouTube coming from a computer cannot be played.

A. We do not guarantee the playback of all video files of all the video streaming sites.

Depending on the video files on the video streaming site, it may not be possible to display the video file. It depends on the security settings of the device that plays the video or the security settings of the video streaming site.

Q. Is HDCP supported?

A. HDCP is not supported. Some video content being input to the HDMI Input from Blu-ray players etc. may not be displayed. Playing protected content may terminate the mirroring session.

Q. It is not possible to record audio during the mirroring.

A. It is a specification. Audio sources that can be recorded are the built-in microphone's audio, the external microphone's audio, and the wired input audio. You can change the audio source to be recorded by changing the microphone settings.

Q. Audio of the HS-2 is not output from the HDMI Output or USB speaker.

A. • The audio settings are not set correctly.

→ Check the audio settings.

• **The audio of the input device is set to mute, or the HS-2 is muted.**

→ Unmute the input device or the HS-2.

• **There is no audio output from the HDMI output, USB external microphone, USB speaker, or USB mic.&speaker.**

→ When an external device such as a USB mic.&speaker is connected, the output audio source automatically changes to the connected device from the HDMI output. When a USB mic.&speaker is connected, no audio is output from the built-in microphone and the HDMI output.

→ For the USB connection (USB external microphone, USB speaker, or USB mic.&speaker), the one connected later has priority. When more than 2 units of USB devices are connected, only the one connected later can be used.

→If you insert and remove the USB device continuously, the audio may not switch normally. Make sure to insert it slowly after confirming that the audio is switched.

•**USB external microphone, USB speaker, or USB mic.&speaker is not recognized.**

→Some USB devices may not be used. Check whether it can be used with the HS-2 in advance.

•**After initialization, there is no audio from the input device.**

→The problem may be improved by opening the settings.

Q. Microphone audio is not recorded during video recording.

A. “Microphone mute” in the Recording settings is enabled or the microphone is disabled.

→If “Microphone mute” is enabled or the microphone is disabled, microphone audio is not recorded.

■ App

Q. PIN settings are not reflected.

A. PIN settings can only be set for Airplay. PIN settings cannot be set for MiraCast and Chrome(Google)Cast.

Q. The setting item is grayed out and cannot be set.

A. • The Proxy settings are disabled.

→If the Proxy settings are disabled, the setting items are grayed out and cannot be set.

•**The PIN settings are disabled.**

→If the PIN settings are disabled, the setting items are grayed out and cannot be set.

•**The 4K input setting is enabled.**

→If the 4K input setting is enabled, the Cast settings are grayed out. Disable the 4K input setting.

•**The AP channel and the MiraCast channel are close to each other.**

→To prevent channel interference, grayed out channels cannot be selected without changing the other channel.

■ Other

Q. I want to know where to save the captured still image file or recorded video file. The captured still image file or recorded video file is not saved. The captured still image file or recorded video file does not appear in the File app.

A. If you are looking for the saved file in "Images" or "Videos" of the File app, it will be displayed in “Images” or “Videos” of the File app after turning off and on the HS-2.

Internal storage: Select a file from the Home screen and select “HS-2” (internal storage).

Save destination of the captured still image file and recorded video file: /HS2/DCIM folder

SD card, USB flash drive: Select a file from the Home screen to display the storage option. Then select the storage.

Save destination of the captured still image file: /Android/data/jp.co.elmo.hs2paint/files/DCIM folder

Save destination of the recorded video file: /Android/data/jp.co.elmo.hs2display/files/DCIM folder

•**There is not enough space in the storage.**

→Check the capacity of the internal storage or external memory device, and then save again.

Q. It is not possible to connect to the Internet.

A. A proxy is set for your network.

→You can connect to the Internet by setting the proxy on the HS-2.

•**HS-2 is connected to an external network via Wi-Fi or LAN.**

→Check the Wi-Fi or LAN connection status. Try again after connecting the HS-2 to the external network.

- Q. I want to change the settings such as SSID and password.**
A. You can change SSID and password for the HS-2 AP. You cannot change the name of DeviceName (the MiraCast connection destination).
- Q. I want to install a network certificate.**
A. It is not possible to install a network certificate at the moment.
- Q. The supplied remote control does not work.**
A. Immediately after the power of the AC adapter is turned on, negotiation between the remote control and the HS-2 starts. This process may take up to 10 seconds. If the remote control still does not work, perform a pairing again.
If there is an error in the app, the remote control may become unusable. In that case, restart the HS-2 and the remote control may start to work again.
- Q. The Capture button and the Hs2Display button on the remote control do not work.**
A. These buttons can only be used in the Hs2Display screen and the Home screen. If you want to take a screen capture with the Browser app, use the screen capture function of the Paint app.
- Q. Some functions cannot be operated with the D-pad or buttons on the main unit.**
A. Rather complicated operations such as typing texts cannot be done by using only the D-pad on the main unit. Use the mouse functions of the supplied remote control too.
- Q. If the power of the monitor is turned off, the power of the HS-2 is also turned off.**
A. The HS-2 is partially compatible with CEC. By turning off the power of the monitor that supports CEC, the power of the HS-2 may also be turned off.
- Q. External memory device (such as USB flash drive or SD card) is not recognized.**
A. Check if the memory device is inserted correctly. The SD card may not be recognized if it is inserted before starting the HS-2. In that case, insert it again.
- Q. Is it possible to connect a Bluetooth compatible device?**
A. Do not use anything other than the supplied remote control. The HS-2 may not work properly if it is connected to other devices.
- Q. Time setting is not displayed correctly.**
A. Go to [System] > [Date and Time] > [Select Time Zone] to set the time zone.
If the HS-2 is not connected to the Internet, time information cannot be obtained.
- Q. When I connect to the Internet by connecting to the AP of the HS-2 via Wi-Fi, the network is slow.**
A. Up to 16 devices can be connected to the AP of the HS-2 at the same time. The problem may be improved by reducing the number of connected devices.
Also, as the HS-2's AP function is designed for the mirroring, the network speed may be slower depending on the type and number of connected devices compared to general access points.
Prepare a separate access point according to your environment.

8 TROUBLESHOOTING

◆ SYMPTOMS AND SOLUTIONS

Check the following items. If any abnormality is found, consult the dealer from whom you purchased this product or our nearest branch/office.

Symptom	Possible cause/ remedy
No image is displayed.	<ul style="list-style-type: none"> •The cable is not correctly connected. (Input cable / Output cable) •The power cable is disconnected from the wall outlet. •Wrong HDMI cable is used. •The HDMI cable is damaged (disconnected). •The AC adapter is disconnected from the power supply socket of the HS-2. •The power is not ON. (Check whether the Power button lights up blue.) •Reconnect the AC adapter, power cable or other cables. •The power of the connected HDMI device or the device connected to the USB Type-C port is not ON. •To mirror the image of a mirroring compatible device, the connection settings must be completed in advance. Complete the Wi-Fi settings for each device and select the HS-2 from the list of connection destinations. •If you turn on the power immediately after turning off, the HS-2 may not start. Wait several seconds after turning off the power and then turn on. •Data format of the input image is not supported by HS-2. Make sure that the data format of the image to be input is supported by the HS-2. •Video data and audio data protected by HDCP cannot be output.
The output image (resolution) changes automatically.	When a monitor is connected, the displayed image (resolution) is automatically changed according to the information from the connected monitor.
An abnormal image such as a sandstorm is displayed.	There is a problem with the signal transmission. Check that the cables are properly connected.
The color of the image is strange.	The setting of the output device is not correct. Check the setting of the output device.
It is not possible to control the HS-2 from the remote control.	<ul style="list-style-type: none"> •The remote control can only be used when the power of the HS-2 is ON. (The LED is lit in blue). Press the Power button to turn on the HS-2. •Immediately after the power of the HS-2 is turned on or the battery of the remote control is inserted, communication with the HS-2 is started by pressing the button on the remote control. In some cases, it may take up to 7 seconds after you press a button on the remote control before it becomes available, but you can use it by pressing the button several times. •The battery level of the remote control is low. Replace the battery. •The battery of the remote control is inserted in the wrong polarity. Make sure that the " + " mark is visible from the back of the remote control when installing the battery. •Perform a pairing with the remote control. (Refer to ◆PAIRING OF THE REMOTE CONTROL (P.37) for details.)

It is not possible to record videos.	<ul style="list-style-type: none"> •The SD card or USB flash drive is not inserted. •The SD card or USB flash drive is broken. •There is not enough space in the storage.
No audio is recorded when recording videos.	The microphone is set to mute.
It is not possible to connect the HS-2 to the network.	<ul style="list-style-type: none"> •The connected router is in stealth mode. •The DHCP of the connected router is disabled. <p>Enable DHCP or set the IP setting of the HS-2 to fixed IP address.</p> <ul style="list-style-type: none"> •The proxy is set. •Wi-Fi signal may be weak. Check the radio wave condition of the external AP.
It is not possible to do the mirroring.	Mirroring may not be possible depending on the security settings of the device. Change the security settings such as temporarily turning off the firewall settings.
Projected video is jerky and not smooth.	<ul style="list-style-type: none"> •The CPU of the device is not powerful enough. In order to project a screen with a lot of movement like a movie, compared to a video with little movement like a presentation, a high-spec device is required. •The network environment is not good enough. (For example, the Wi-Fi signal is weak.) <p>Improve the network environment by changing the Wi-Fi channel of the HS-2 or the wireless channel of the Wi-Fi access point or the layout of each device.</p>
No audio is output.	<ul style="list-style-type: none"> •A monitor or projector that cannot output audio is used. •The audio volume of the monitor or projector is set to 0 or is set to mute. •The audio setting of the monitor or projector is not set to HDMI input. •The audio volume of the device to be mirrored is set to 0 or is set to mute. •The audio volume of the HS-2 is set to 0 or is set to mute.
Error message appears when entering the password.	Wrong password has been entered. (For example, uppercase letter is used for lowercase letter or number "0" is used for alphabet "O".) Enter the password correctly.
DeviceName, SSID, and Password are not displayed in the screen.	Go to [Settings] > [Hs2Display settings] > [Connection destination display] and set it to "Show".
"Fan error" message is displayed.	The built-in fan is broken. Request replacement of the fan.

About long-term usage of the product

•Due to the lifetime of its parts, if this product is used for longer than the warranty period, its performance and quality may deteriorate. In this case, we will replace the parts for a charge. Consult the dealer from whom you purchased this product or our nearest branch/office.

9 SPECIFICATIONS

Item	Specifications
Power Source	DC12V/2A (AC adapter AC100V - 240V 50/60Hz)
Power consumption	24 W
Outside dimensions	W : 214mm D : 114mm H : 37mm
Weight	470g
Operating temperature	0°C~40°C
Humidity	30%~85% (No condensation)
OS	Android 9.0
Video output	
Output port	HDMI Output port (Type-A) X1
Network	Video streaming
Split screen	Displays max. 4 split images on a single screen of the connected devices to the HS-2.
Save destination	Internal storage, SD card, USB flash drive
Video input (wired)	
Input port	HDMI (Type-A)×1、USB(Type-C)×1
Compatible HDMI input devices	Video equipment and computers equipped with an HDMI output port
HDMI audio	Yes
HDCP	Not supported.
Compatible USB(Type-C) input devices	Computers that support DisplayPort Alternate Mode (video output function) (such as Mac and ChromeBook)
USB audio	Yes
HDCP	Not supported.
Video input (wireless)	
Supported mirroring protocols	AirPlay、MiraCast (with touch back function)、Chrome(Google)Cast
Supported OS for mirroring	Mac OS (OS X 10.11 or later) 、iOS(iOS10 or later)、iPad OS、Android OS (5.0 or later) 、Windows OS (8.1 or later) Chrome OS
Supported input resolution	Max.1920×1080p
Audio	Yes
HDCP	Not supported.
Audio input / output	
Built-in microphone	Yes (MEMS mic. X1)
Audio input	HDMI input, USB(Type-C) input, USB mic., network
Audio output	HDMI output, USB speaker, network
USB	
Input / output port	USB host ports (Type-A) X4 (USB 2.0X3 + USB 3.0 X1) with bus power (4 ports, total 1.5A)
Supported device class	HID, Mass storage, UVC, UAC, HUB Possible to connect a USB mic.& speaker.

Storage	
Internal storage	16GB (including OS and apps)
SD card	SD slot×1 for SD card and SDHC card (Class10 or higher)
USB flash drive	Still image recording / video recording (with audio)
Bluetooth	
Remote control	16 buttons + Gyro mouse
Network	
LAN	10BASE-T, 100BASE-TX, 1000BASE-T
Wi-Fi	IEEE 802.11 ac/a/b/g/n
Authentication method (Wi-Fi)	Open system, WPA-PSK, WPA2-PSK, 802.1x-EAP

◆VIDEO INPUT

•HDMI video input format

Resolution		Aspect ratio	Frequency
3840×2160p	UHD, 4K	16 : 9	24/25/30Hz
1920x1080p	FHD, 2K	16 : 9	24/25/30/50/60Hz
1280x720p	HD	16 : 9	50/60Hz
1024x768	XGA	4 : 3	60Hz

•Wi-Fi video input format

Resolution		Aspect ratio	Frequency
1920x1080p	FHD, 2K	16 : 9	24/25/30Hz
1280x720p	HD	16 : 9	50/60Hz

•USB (Type-C) video input format

Resolution		Aspect ratio	Frequency
3840×2160p	UHD, 4K	16 : 9	24/25/30Hz
1920x1080p	FHD, 2K	16 : 9	24/25/30/50/60Hz
1280x720p	HD	16 : 9	50/60Hz

◆VIDEO OUTPUT

•HDMI video output format

Resolution		Aspect ratio	Frequency
3840×2160p	UHD、4K	16 : 9	30Hz
1920x1080p	FHD、2K	16 : 9	60Hz
1280x720p	HD	16 : 9	60Hz
AUTO	-	-	-

◆VIDEO RECORDING

Save destination	Internal storage SD card and SDHC card (Class10 or higher) USB flash drive
Recording format	H.264, AAC
Recording quality	High / Normal / Low
Video file size / frame rate	High : 8Mbps 1920x1080@30fps Normal : 6Mbps 1920x1080@30fps Low : 4Mbps 1920x1080@30fps
Audio recording	Built-in mic. / External mic. / HDMI audio / USB Type-C audio / no audio
Recording restriction	The maximum recording file size is 4GB. If the file size exceeds 4GB, it will be saved in multiple files.

◆STILL IMAGE RECORDING

Save destination	Internal storage SD card and SDHC card (Class10 or higher) USB flash drive
File size	1920×1080
File format	JPEG

◆LIST OF SUPPORTED MEDIA TYPES

Media type	Extension	Description
Still image	JPG/PNG/BMP	Jpeg file/Png file/Bmp file
Video	MP4	MP4 file
PDF	pdf	PDF file
Excel	xlsx, xls	Excel file
PowerPoint	pptx, ppt	PowerPoint file
Word	docx, doc	Word file

◆SYSTEM REQUIREMENTS

Windows	Windows 8.1/10 CPU : Intel Core i5 (with processor higher than 2GHz) RAM : More than 2GB (RAM more than 8GB recommended)
Android	Android 5.0 or later
Mac OS	Mac OS : 10.11 or later CPU : Intel Core i5 equivalent (Multi-core processor) Memory : 4GB or more (Memory more than 8GB recommended) Disk capacity : 300MB or more free space
iOS	iPhone5 or later System version : iOS 10 or later
Chrome OS	All versions of Chrome OS Memory : 4GB or more

※It may be possible to do casting via Chrome browser running on OS other than the above (such as windows7)

■ TRADEMARKS AND LICENSES

ELMO is a registered trademark of TECHNO HORIZON CO., LTD.

SD, SDHC, and  logo are trademarks of SD-3C,LLC.

HDMI and High-Definition Multimedia interface are trademarks or registered trademarks of HDMI Licensing LLC.

Windows and other Microsoft products referenced herein are registered trademarks of Microsoft Corporation in the U.S. and other countries.

Google, Google Chrome, Android, Chromecast and YouTube are registered trademarks of Google Inc.

MiraCast is a registered trademark of Wi-Fi Alliance.

AirPlay is a registered trademark of Apple Inc. in the U.S. and other countries.

All other company and product names described in this manual are trademarks or registered trademarks of their respective companies.

This product is licensed under the AVC Visual Patent Portfolio License (AVC Video) for the personal and non-commercial use of a consumer to

(i) Play AVC Video that was recorded by a consumer engaged in a personal and a non-commercial activity and/or,

(ii) Play AVC Video that was obtained from a video provider licensed from MPEG-LA, LLC.

Additional information including that relating to promotional and commercial uses may be obtained from MPEG-LA, LLC.

Bluetooth® is a trademark or registered trademark of Bluetooth SIG, Inc. USA.

Attention

- Unless used for personal use, it is prohibited by copyright law to record slides, books and photos without the prior consent of copyright holder.
- This product is designed to be used in industrial environment. If it is used in a residential area or in an adjacent area thereto, harmful interference to radio or television reception may occur.
- Repair parts

Repair parts are the items which are needed to maintain product functionality. The holding period of such repair parts is 5 years after the product discontinuation, which is equal to the repair period we will accept.

テクノホライゾン株式会社

〒457-0071
名古屋市南区千竈通二丁目13番地1
Web : <https://www.elmo.co.jp>

製品のお問い合わせは、下記オフィスへ

- 札幌オフィス
〒060-0908 札幌市東区北8条東3丁目1-1
宮村ビル3F
TEL.011-594-8450
- 仙台オフィス
〒980-0802 仙台市青葉区二日町13番18号
ステーションプラザビル6階
TEL.022-266-3255
- 東京オフィス
〒108-0075 東京都港区港南二丁目16番4号
品川グランドセントラルタワー17階
TEL.03-3471-4577
- 名古屋オフィス
〒457-0078 名古屋市南区塩屋町一丁目3番地4
TEL.052-811-5261
- 京都オフィス
〒604-8101 京都市中京区柳馬場御池下る柳八幡65
京都朝日ビル10階
TEL.075-744-1360
- 大阪オフィス
〒550-0002 大阪市西区江戸堀1丁目9番6号
肥後橋ユニオンビル10階
TEL.06-6443-6001
- 姫路オフィス
〒670-0912 兵庫県姫路市南町63
ミツビル1階
TEL.079-257-1636
- 広島オフィス
〒730-0012 広島県広島市中区上八丁堀4-1
アーバンビューグランドタワー1104号室
TEL.082-221-2801
- 福岡オフィス
〒812-0039 福岡市博多区冷泉町2番8号
朝日プラザ祇園2階
TEL.092-281-4131
- 熊本オフィス
〒862-0976 熊本市中央区九品寺1丁目11番4号
熊本県教育会館4階
TEL.096-282-8338

TECHNO HORIZON CO., LTD.

2-13-1 Chikamatori Minami-ku
Nagoya, 457-0078, Japan

OVERSEAS SUBSIDIARY COMPANIES

ELMO USA CORP.

Headquarters
6851 Jericho Turnpike
Suite 145
Syosset, NY 11791
Tel. (516) 501-1400
Fax.(516) 501-0429
E-mail : elmo@elmousa.com
Web : <https://www.elmousa.com/>

ELMO Europe SAS

Headquarters
60, av. Charles de Gaulle
92200 Neuilly - sur - Seine
FRANCE
Tel. +33 (0) 1 73 02 67 06
Fax. +33 (0) 1 73 02 67 10
E-mail : info@elmoeurope.com
Web : <https://www.elmoeurope.com/>

German Branch

Monschauerstr. 1
40549 Düsseldorf
Tel. +49 (0) 211 544756 40
Fax. +49 (0) 211 544756 60

Middle East (Branch)

5WA-129, Dubai Airport Free Zone
P.O. Box 371556, Dubai,
United Arab Emirates
Tel. +971-(0)4-260-2390
Fax. +971-(0)4-260-2392