

DS-D5B86RB/C Interactive Flat Panel



The Interactive Flat Panel (hereafter referred to as the “device”) integrates functions of computers, projectors, interactive whiteboards, sound boxes, cameras (optional), bluetooth remote control (optional), HDTVs, advertising machines and so on. The device integrates technologies like 4K display, infrared touch, human-machine interaction, multi-media information processing, and network transmission and provides users with various features such as writing, annotating, multi-screen sharing, pen detection and remote video call (optional). The Interactive Flat Panel is mainly used for remote video conferences, trainings and guidance, medical consulting, and other events in kinds of offices, meeting rooms, multi-media classrooms, exhibition halls and so on.

- Ultra HD display with up to 3840 × 2160 resolution of input signal available.
- 20px ultra fine writing, and 2 mm diameter recognizable with the precision of 1 mm.
- Built-in Wi-Fi realizes screen sharing without any cable connection.
- Built-in interactive whiteboard system allows annotating and sharing by QR code.
- Looping-out display available.
- Various audio and video interfaces for device access.
- Built-in network switch chip saves a network switch.
- Built-in Android system provides kinds of applications.
- Compatible with OPS/OPS-C devices, realizing smooth switch between built-in systems.
- Ultra-thin design with aluminum profile frame.

▪ Specification

Model		DS-D5B86RB/C
Product Model	Product Model	DS-D5B86RB/C
Display	Screen Size	86 inch LED Backlight
	Backlight	DLED
	Pixel Pitch	0.164 (H) × 0.493 (V) mm
	Resolution	3840 × 2160@60 Hz
	Brightness	350 cd/m ²
	Color Depth	10 bit
	Contrast Ratio	1200 : 1 (Typ.)
	Response Time	6 ms
	Color Gamut	90% NTSC (CIE1931) (Typ.)
	Refresh Rate	60 Hz
	Viewing Angle	178° (H) / 178° (V)
Built-in System	Operation System	Android 11
	Processor	A72*2 + A53*4, 1.8 GHz
	Memory	4 GB
	Built-in Storage	64 GB
	NIC	Built-in 1000 Mbps NIC, supporting routing; IEEE 802.11 a/b/g/n/ac with 2 × 2 MIMO, supporting both 2.4 GHz and 5GHz bands
Touch	Type	Infrared touch screen
	Glass	AG smooth glass
	Touch Point	Max 45 point multi-touch
	Touch Response Time	< 10 ms
	Touch Precision	± 1 mm (≥ 90% touching area)
Internal Function	Loudspeaker	Built-in 2 × 16 W loudspeaker
	Bluetooth	Built-in BLE (Bluetooth Low Energy) module supports Bluetooth 5.0 and previous version
Interface	Video & Audio Input	HDMI IN × 2, MAX 4K @30 Hz, LINE IN × 1
	Video & audio output	HDMI OUT (HDMI 2.0) × 1, MAX 4K @60 Hz, LINE OUT × 1
	Control interface	RS-232 × 1, Touch-USB × 1
	Network Interface	RJ45 (1000 Mbps port) × 2

	Data Transmission Interface	USB-C × 1, USB-A × 2 on front panel, USB-A × 2 on rear panel
Power	Power Consumption	≤ 490 W (full load)
	Standby Consumption	0.5 W
Working Environment	Working Temperature	0 °C to 40 °C (32 °F to 104 °F)
	Working Humidity	10% to 90% RH
General	Power	100 to 240 V, AC, 50/60 Hz
	Product dimensions	1963 × 1159 × 87.5 mm
	Package Dimensions (W × H × D)	2187 × 1366 × 274 mm
	Net Weight	65.12 kg
	Gross Weight	86.24 kg
	Lifespan	50000 hours

▪ Physical Interface

Interface	Description	Interface	Description
1.LINE OUT	Earphone Interface	2.LINE IN	Audio Input Interface
3.RS-232	RS-232 Serial Port	4.TOUCH-USB	Peripheral Touch Interface
5.LAN 2	Ethernet Interface 2	6. LAN 1	Ethernet Interface 1
7.HDMI 2	HDMI Input Interface 2	8.HDMI 1	HDMI Input Interface 1
9.USB 3.0	USB 3.0 Interface	10.MULTI-USB	Multi-functional USB Interface
11.HDMI OUT	HDMI Output Interface		

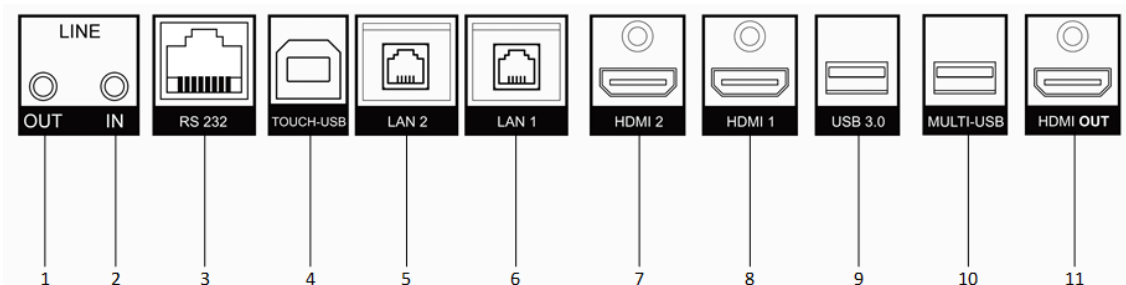

▪ Available Model

DS-D5B86RB/C

▪ Dimension

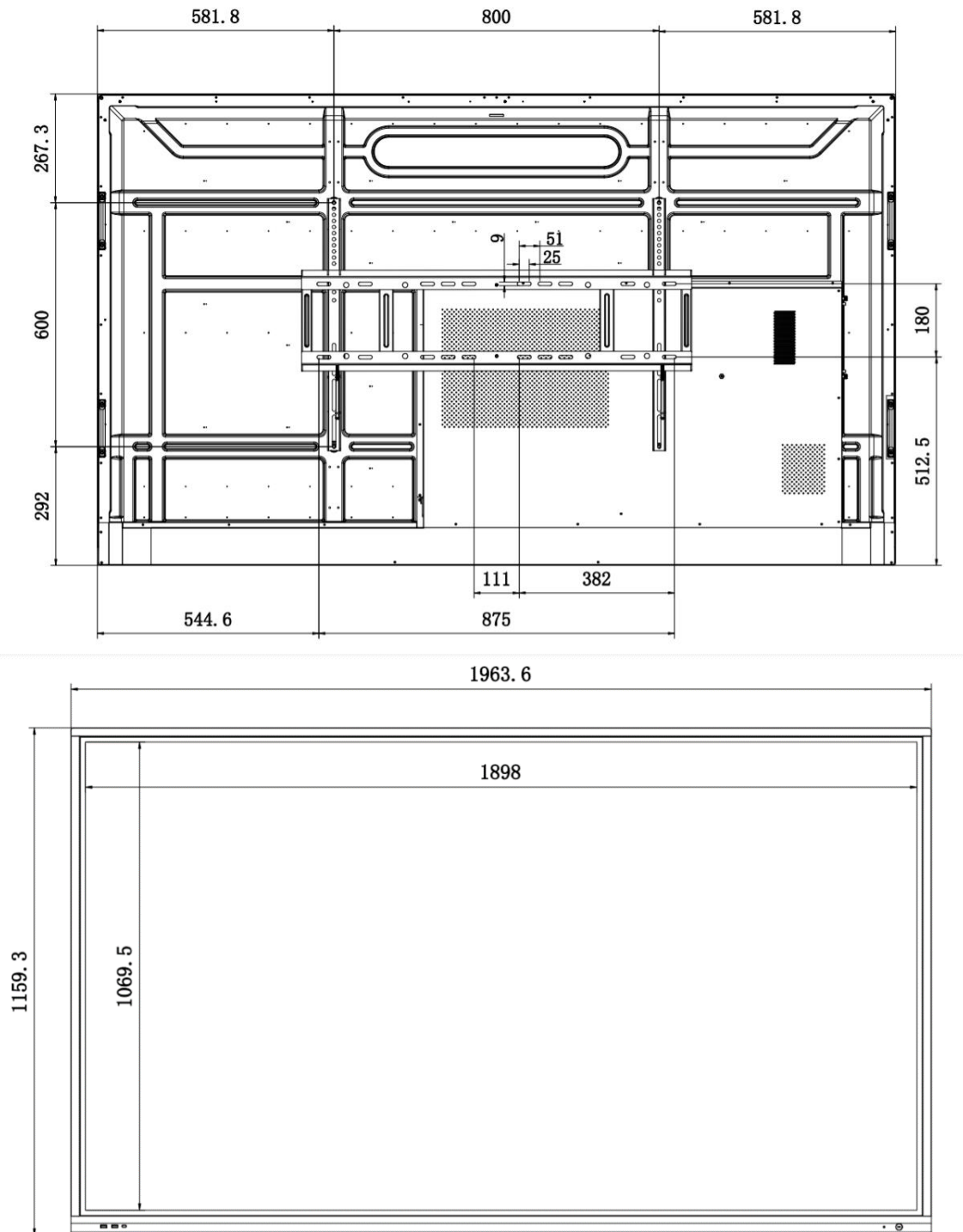

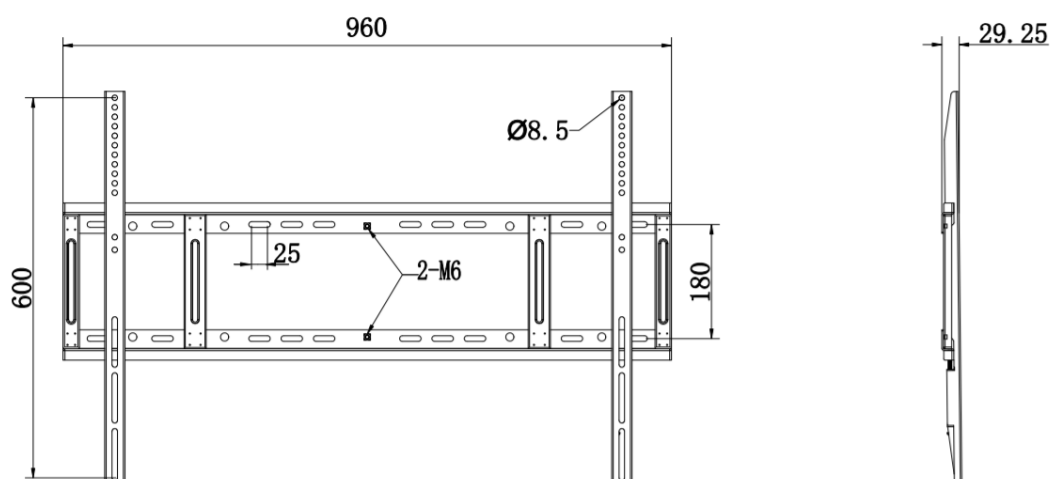

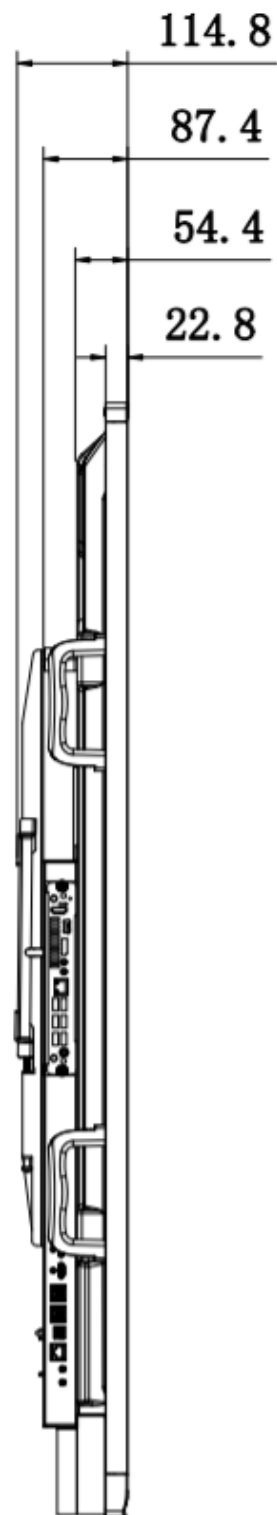

Headquarters

No.555 Qianmo Road, Binjiang District,
Hangzhou 310051, China
T +86-571-8807-5998
www.hikvision.com



Follow us on social media to get the latest product and solution information.

